

PUBLIC

WESM Market Manual

Dispatch Protocol Issue No. 13.2

Abstract	This document covers the <i>timetable</i> and procedures on <i>dispatch</i> scheduling and implementation in the <i>WESM</i>
----------	--

Document Identity: WESM-DP-013.2
Issue: 13.2
Reason for Issue: Amendments to reflect changes to the WESM Timetable regarding market run activities per DOE DC 2020-10-0020.
Approval Date: 06 October 2020
Publication Date: 22 October 2020
Effective Date: *Revisions to the WESM-DP will be effective upon the commencement of the New Market Management System to be set by the DOE.*

Document Change History

Issue No.	Proponent	Date of Effectivity	Reason for Amendment
0	MO, PEMC	02/07/2005	New Document / Draft Format
2	MO, PEMC	03/10/2005	Minor revisions were introduced based on consolidated <i>WESM-TWG</i> comments
	MO, PEMC	01/12/2006	Revision of procedures during <i>market suspension</i> and intervention.
3			Inclusion of procedures on revision of <i>bids</i> and <i>offers</i> in Appendix A-1.
	MO, PEMC	07/06/2006	Revision of gate closure period from four to two hours before RTD execution, found in Appendix A.1, Section 4.4.
4	MO, PEMC	02/28/2007	Revision of Appendix A.1, Section 4.5 to allow cancellation of <i>bids/offers</i> and Glossary to include definition of maximum available capacity
5	Rules Change Committee	02/11/2008	Revision of Appendix A.1 Section 4.4 to change gate closure from two hours to one hour
6	PEMC	09/29/2010	Revision of Appendix A.4, Section 4.4. and Appendix A.6, Section 4.2 to remove <i>contingency</i> list from the Ex-Post Process (<i>approved by the PEM Board as Urgent Amendments on 27 October 2010 and as General Amendments on 28 April 2011</i>)
7	Generators, PEMC-MO, NGCP-SO	11/15/2012	Revisions to: <ol style="list-style-type: none"> a. Include the Merit Order Table (MOT) in pertinent sections of the Manual b. Add definition of MOT in Glossary of Terms and Abbreviations c. Include detailed procedures on the <i>generation</i> of MOT (Attachment D.1) d. Clarify the implementation of re-<i>dispatch</i> process on a per case basis e. Include SO's responsibility in logging and reporting to MO any deviation of their <i>dispatch instructions</i> from the RTD schedule
8	PEMC-MO	05/21/ 2013	f. Revision of Appendix A.1 to remove the provision "at any time" and replace it with provisions on gate closure, to reflect the changes made in the <i>WESM Rules</i>
9	PEMC-MO	02/19/2013	<ul style="list-style-type: none"> • Additional Appendix A.12 on the Scheduling and <i>Dispatch of Reserves</i>
10	PEMC-MO	08/04/2014	<ul style="list-style-type: none"> • Re-submission of approved urgent amendments as general amendments(Additional Appendix A.12 on the Scheduling and <i>Dispatch of Reserves</i>)

Issue No.	Proponent	Date of Effectivity	Reason for Amendment
11	RCC	09/29/2014	<ul style="list-style-type: none"> • Revision of Dispatch Protocol Manual pursuant to DOE Directives relative to the Manual on the Management of Must Run Units
12	PEMC-MO		<ul style="list-style-type: none"> • Revised format of entire document to address findings and recommendations of the PA Consulting Services Ltd. in its operational audit reports, with revisions including the following – <ul style="list-style-type: none"> ○ Added references to provisions of the <i>WESM Rules</i> relevant to each procedure ○ Clarified statements of responsibilities pertaining to the <i>Market Operator, System Operator and Trading Participants</i> • Added the following sections <ul style="list-style-type: none"> ○ <i>Start-up and shutdown of generating units</i>, thus merging the <i>WESM Manual on Procedures for Start-up and Shutdown of Generating units</i> • Deleted appendices/sections on the following as these are already covered in separate <i>Market Manuals</i> – <ul style="list-style-type: none"> ○ Load forecasting methodology or demand forecasting ○ <i>Market Operator</i> information publication • Revised Glossary to remove terms and abbreviations which are already defined in the <i>WESM Rules</i> • Incorporated provisions on <i>dispatch tolerance standards</i> • Revised the definition of maximum available capacity to basically reflect that <i>co-generation facilities'</i> maximum available capacity is net of their <i>load</i>. • Revised provisions on <i>Market intervention and Market suspension</i> to align the Manual with recent <i>WESM Rules</i> changes on <i>Market intervention and Market suspension</i> • Intended to align several affected provisions of the DPM with the promulgated amendments to the <i>WESM Rules</i> for the implementation of preferential <i>dispatch</i>, per DOE Department Circular No. DC2016-01-0002.
13	PEMC		<ul style="list-style-type: none"> • Implementation of enhancements to <i>WESM</i> design and operations in accordance with DOE Department Circular No. DC2015-10-0015, which provides, among others, 5-minute <i>dispatch intervals</i>.

Issue No.	Proponent	Date of Effectivity	Reason for Amendment
13.1	Technical Committee		<ul style="list-style-type: none"> • Reflect amendments relevant to Participation of Battery Energy Storage Systems and Pumped-Storage Units in the WESM
13.2	IEMOP		<ul style="list-style-type: none"> • Amendments to reflect changes to the WESM Timetable regarding market run activities per DOE DC 2020-10-0020.

Document Approval

Issue No.	RCC Approval	RCC Resolution No.	PEM Board Approval	PEM Board Resolution No.	DOE Approval	DOE DC No.
0	15 March 2005		16 May 2005	2005-08		
2	05 January 2006	2006-06	19 January 2006	2006-03		
	12 January 2006	2006-07	19 January 2006	2006-05		
3	06 July 2006	2006-21	06 July 2006	2006-32		
	14 November 2006	2006-36	17 November 2006	2006-63		
4	15 February 2007	2007-03	28 February 2007	2007-03		
5	28 January 2008	2008-01	11 February 2008	2008-02		
5	18 August 2010	2010-11	05 October 2010	2010-64		
6	13 October 2010 <i>(as Urgent Amendments)</i>	2010-13	27 October 2010 <i>(as Urgent Amendments)</i>	2010-73		
	06 April 2011 <i>(as General Amendments)</i>		28 April 2011 <i>(as General Amendments)</i>	2011-26		
7	08 February 2012	2012-02	27 February 2012	2012-08		
8	07 August 2013	2013-08	29 August 2013	2013-46		
	21 February 2014	2014-07	27 February 2014	2014-11		
10	10 September 2014 <i>(as General Amendments)</i>	2014-17	29 September 2014 <i>(as General Amendments)</i>	2014-43		
	10 September 2014	2014-13	29 September 2014	2014-44		
12	05 October 2016	2016-11	29 November 2017	2016-39	20 April 2017	2017-004-0007
13	07 July 2017	2017-08	18 September 2017	2017-16	28 March 2018	2018-04-0007
13.1	04 May 2018	2018-04	30 May 2018	2018-27	06 August 2018	2018-08-0022
13.2	08 Nov 2019	2019-16	27 Nov 2019	2019-18-08	08 Oct 2020	2020-10-0020

Reference Documents

Document ID	Document Title
	WESM Rules
	Philippine Grid Code
	Price Determination Methodology
	WESM Manual - Load forecasting Methodology
	WESM Manual - Market Network Model Development and Maintenance – Criteria And Procedures
	WESM Manual - Market Operator Information Disclosure and Confidentiality Manual
	WESM Manual - System Security and Reliability Guidelines

Table of Contents

SECTION 1	INTRODUCTION	11
1.1	Overview of WESM Operations	11
1.2	Purpose	13
1.3	Scope	14
SECTION 2	DEFINITIONS, REFERENCES AND INTERPRETATION	14
2.1	Definitions	14
2.2	References	17
2.3	Interpretation	18
SECTION 3	RESPONSIBILITIES	18
3.1	Market Operator	18
3.2	System Operator	18
3.3	Trading Participants and other WESM Members	18
SECTION 4	WESM TIMETABLE	19
4.1	Background	19
4.2	Scope of the WESM Timetable	20
4.3	Week-Ahead Projection (WAP)	20
4.4	Day-Ahead Projection (DAP)	21
4.5	Hour-Ahead Projection (HAP)	23
4.6	Real-Time Dispatch Schedule (RTD)	24
SECTION 5	MARKET INFRASTRUCTURE	25
5.1	Background	25
5.2	Overview on the Energy Management Applications	26
5.3	Overview on the Market Applications	26
SECTION 6	BIDS, OFFERS AND DATA SUBMISSION AND PROCESSING	27
6.1	Background	27
6.2	Scope	28
6.3	Responsibilities	28
6.4	Categories of Self-scheduled Nominations, Bids, and Offers	28
6.5	Requirements for Self-scheduled Nominations, Bids, and Offers	29
6.6	Open Market Window	29
6.7	Market Participant Interface	30
6.8	Types of Self-scheduled Nominations, Bids, and Offers	30
6.9	Format and Contents of Submissions	31
6.10	Acknowledgement of Self-scheduled Nominations, Bids, and Offers	32
6.11	Updating of Self-scheduled Nominations, Bids, or Offers	32

6.12	Validation of Self-scheduled Nominations, Bids, and Offers	33
6.13	Revisions of Self-scheduled Nominations, Bids and Offers Based on Reasonable Estimates	33
6.14	Report of Material Adverse Change in State of Trading Participant Facilities	33
SECTION 7	SYSTEM OPERATOR INPUT DATA AND REPORTS	34
7.1	Background	34
7.2	Scope and Purpose	35
7.3	Responsibilities	35
7.4	Data and Report Requirements	36
7.5	Outage Schedules	36
7.6	Over-riding Constraints	36
7.7	Contingency List Requirements	37
7.8	Reserve Requirements	38
7.9	System Status	38
7.10	Means of Submission/Transmittal	38
7.11	Publication of System Operator Data	38
SECTION 8	MARKET PROJECTIONS	39
8.1	Background	39
8.2	Scope and Purpose	39
8.3	Responsibilities	40
8.4	Data Inputs/Information Requirements	40
8.5	Outputs/Results of Market Projections	41
8.6	Publication and Dissemination of Market Projection Results	41
8.7	Archiving of Market Projections	42
SECTION 9	REAL-TIME DISPATCH SCHEDULING	42
9.1	Background	42
9.2	Purpose and Scope	42
9.3	Responsibilities	42
9.4	Schedule and Coverage of Real-time Dispatch Scheduling	43
9.5	Data Inputs/Information Requirements	43
9.6	Outputs/Results of Real-time Dispatch Scheduling	44
9.7	Dissemination and Publication of Market Run Results	44
9.8	Archiving of RTD Market Runs	45
SECTION 10	PREPARATION OF THE WESM MERIT ORDER TABLE	45
10.1	Background	45
10.2	Purpose and Scope	45
10.3	Responsibilities	45
10.4	Preparation of the WMOT	46

10.5	Output of the WMOT	47
10.6	Use of the WMOT	47
10.7	Reporting and Publication	48
SECTION 11 DISPATCH IMPLEMENTATION		48
11.1	Background	48
11.2	Purpose and Scope	48
11.3	Responsibilities	49
11.4	Issuance and Coverage of Dispatch Instructions	49
11.5	Dispatch of Must and Priority Dispatch Generating Units	50
11.6	Conditions for Re-Dispatch	50
11.7	Re-dispatch Procedures	51
11.8	Communicating and Reporting of Dispatch Schedules and Instructions	51
SECTION 12 DISPATCH COMPLIANCE		52
12.1	Background	52
12.2	Scope and Purpose	53
12.3	Responsibilities	53
12.4	Compliance with Dispatch Schedules and Instructions	54
12.5	Dispatch Conformance Standards	55
12.6	Reporting	57
12.7	Review of the Conformance Standards	58
SECTION 13 START-UP AND SHUTDOWN OF GENERATING UNITS		58
13.1	Scope and Purpose	58
13.2	Responsibilities	58
13.3	General Procedures	59
13.4	Start-up of a Generating Unit	59
13.5	<i>Shutdown</i> of a Generating Unit	59
SECTION 14 POST DISPATCH DATA AND OPERATION REPORTS		60
14.1	Background	60
14.2	Purpose and Scope	60
14.3	Responsibilities	60
14.4	Post-dispatch Reports and Information	60
SECTION 15 SCHEDULING AND DISPATCH OF RESERVES		62
15.1	Background	62
15.2	Scope and Purpose	62
15.3	Responsibilities	62
15.4	Determination of <i>Reserve</i> Requirements	62
15.5	Submission of Reserve Requirements	63

SECTION 16	PROCEDURES DURING MARKET INTERVENTION OR SUSPENSION	63
16.1	Background	63
16.2	Purpose and Scope	63
16.3	Responsibilities	64
16.4	Grounds for Market Intervention and Suspension	65
16.5	Declaration of Market Suspension or Market Intervention	66
16.6	Dispatch Scheduling and Implementation	67
16.7	Power System and Market Restoration	67
16.8	Market Resumption	67
16.9	Settlement of Market Transactions/Administered Price	68
16.10	Report on Market Intervention or Market Suspension	68
16.11	Communications and Notifications	69
16.12	Other Procedures	69
16.13	Process Flows	69
SECTION 17	MANAGEMENT OF MUST-RUN UNITS	74
17.1	Overview	74
17.2	Must-Run Unit Criteria	74
17.3	Considerations and Criteria for Selection of Must Run Units	75
17.4	<i>MRU</i> Scheduling and <i>Dispatch</i> Procedures	76
17.5	Reporting and Publication	77
SECTION 18	EXCESS GENERATION	77
18.1	Overview	77
18.2	Responsibilities	78
18.3	Managing Excess Generation for the Next Day	78
18.4	Managing Excess Generation In Real-Time	79
18.5	Provision of Reports	79
SECTION 19	PROCEDURES FOR <i>LOAD</i> SHEDDING	80
19.1	Overview	80
19.2	Responsibilities	81
19.3	Preconditions / Pre-Requirements	82
19.4	Procedure for Manual <i>Load</i> Shedding	82
SECTION 20	EMERGENCY PROCEDURES	83
20.1	Overview	83
20.2	Scope and Purpose	84
20.3	Responsibilities	84
20.4	Emergency Procedures	86
SECTION 21	AMENDMENT, PUBLICATION AND EFFECTIVITY	91

Dispatch Protocol

WESM-DP-013.2
Effective Date:

21.1	Amendments	91
21.2	Publication	91
21.3	Effectivity	91
SECTION 22 APPENDIX		91
Appendix A. Content Structure of <i>Market projections</i> Results for the <i>System Operator</i>		91
Appendix B. Steps in Creating a Merit Order Table		94
Appendix C. Sample Contents of a Merit Order Table		98
Appendix D. Content Structure of <i>Real-time dispatch</i> Results for the <i>System Operator</i>		99
Appendix E. Content Structure of SO Inputs to the <i>Market projections</i> and <i>Real-time dispatch</i>		101
Appendix F. Counting the Non-Compliance and Possible Breach		104

SECTION 1 INTRODUCTION

1.1 Overview of WESM Operations

- 1.1.1 In the *WESM*, the *Market Operator* provides the *System Operator* with *dispatch schedules* to be implemented by the *System Operator* for each *dispatch interval* using various inputs such as *load forecasts* and state-estimated data from the *Market Operator*, real-time data and *security constraints* from the *System Operator*, and *demand bids*, *market offers*, and *self-scheduled nominations* submitted by the *Trading Participants*.
- 1.1.2 The *Market Operator* uses a *market dispatch optimization model* (MDOM) with a representation of the *power system* so that *transmission constraints* and losses are considered in the preparation of *dispatch schedules*. Self-commitment is adopted in the *dispatch* model instead of centralized unit commitment, consistent with the policy of competition in the *generation* sector as set out in Section 6 of Republic Act No. 9136.
- 1.1.3 By considering the *power system's* topology and characteristics through the *market network model*, the *real-time dispatch* (RTD) schedules generated by the *Market Operator* are security-constrained economic *dispatch schedules*. The *Market Operator* likewise prepares a *WESM merit order table* (WMOT) that presents the list of available *generating units* ranked in accordance with the *offer* prices submitted for these units. The WMOT is submitted to the *System Operator* as a guide in constraining off and on generating units whenever there is a deviation in real-time after *reserves* are exhausted. Post-dispatch reports are thereafter relayed by the *System Operator* to the *Market Operator*.
- 1.1.4 *WESM Rules* Clause 3.4.3 requires the *Market Operator* to operate the market in accordance with a *timetable*, which it is required to maintain, publish and continuously update. The *timetable* shall include the schedule for:
- a. Determining and publishing *market projections*, including the precise specifications of the *market horizon* to be used for such projections;
 - b. Submitting *offers*, *bids* and data;
 - c. If necessary, for any other action to be taken by the *Market Operator*, the *System Operator*, or any *WESM Member* during the operation of the *spot market*.
- 1.1.5 Under this *timetable*, trading activities in the *WESM* operate at different time frames starting from the week before until the day following the *trading day*.
- 1.1.6 The scheduling process starts with the *week-ahead projection* (WAP) which gives the indicative hourly *dispatch schedules* and spot prices for the next seven (7) days. This projection takes into consideration all available information including nomination of *loading levels*, *projected outputs*, *bids* and *offers* from participants, demand forecasts, *outage* schedules and the current status of the *grid*.
- 1.1.7 The *day-ahead projection* (DAP) is prepared every hour covering the hours succeeding each DAP run up to the end of the following day. It utilizes the most recent nomination of *loading levels*, *projected outputs*, *bids* and *offers* of participants as well as

information on *power system* status, *reserve* requirements and *outage* schedules. The *day-ahead projection* allows the *System Operator* to prepare a more accurate *contingency plan* for the succeeding *dispatch intervals* or *trading day*.

- 1.1.8 The *hour-ahead projection* (HAP) is prepared every *dispatch interval* covering the next twelve (12) *dispatch intervals*. It also utilizes the most recent nomination of *loading levels*, *projected outputs*, *bids* and *offers* of participants as well as information on *power system* status, *reserve* requirements and *outage* schedules. The *hour-ahead projection* allows the *Trading Participants* to prepare and submit more appropriate *self-scheduled nominations*, *bids* or *offers*.
- 1.1.9 The *Market Operator* uses the MDOM to provide pre-dispatch *market projections* to provide sufficient information to the *System Operator* and the *Trading Participants* for planning purposes.
- 1.1.10 The *real-time dispatch schedule* generated by the *Market Operator* is comprised of the *energy* and *reserve* schedules. The *energy* schedule contains the *target loading level*, in *MW*, that all facilities should meet at the end of the relevant *dispatch interval*. The *reserve* schedule contains the capacities scheduled for provision of *ancillary services*, but covering only the *reserves* that are traded in the *WESM*.
- 1.1.11 The *System Operator* implements the RTD schedules for the *dispatch interval*, issues *dispatch instructions* to and ensures compliance by the *Trading Participants* with such instructions, and maintains overall *security* of the *power system*.
- 1.1.12 The following figure shows an overview of the operational arrangements between the *System Operator*, *Market Operator*, and *Trading Participants*.

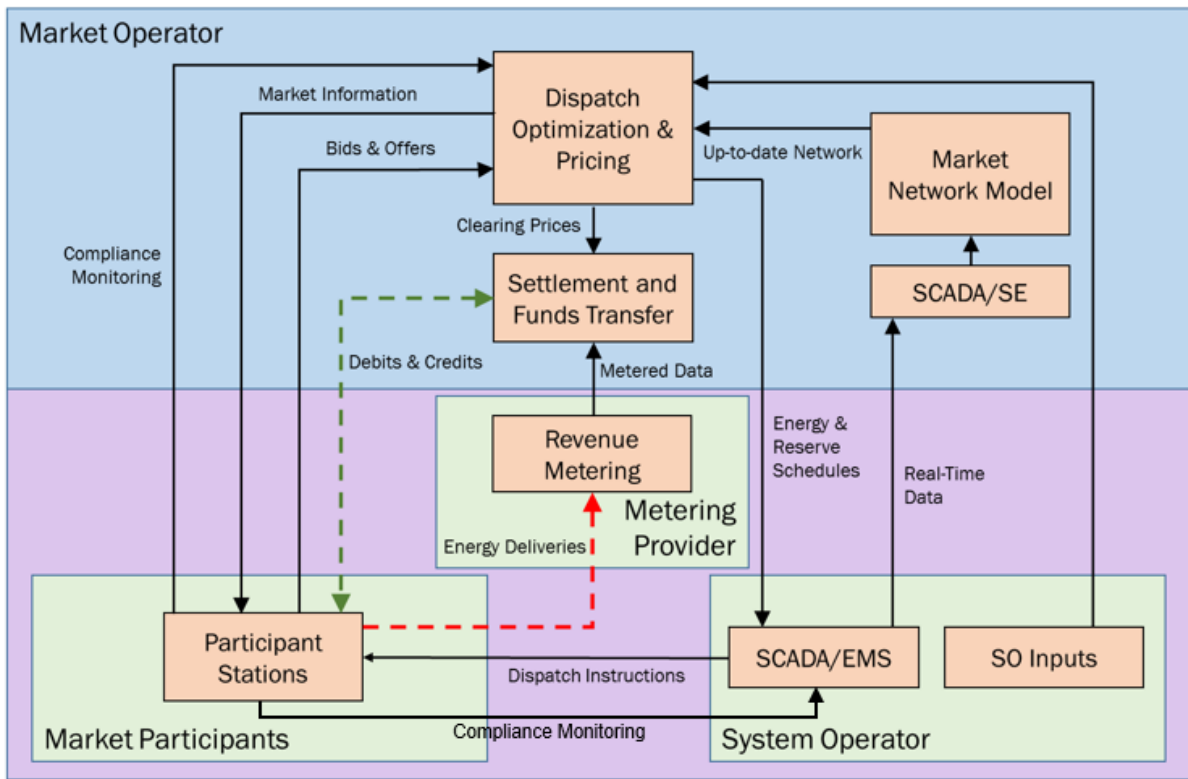

Figure 1. Overview of WESM Operations

1.2 Purpose

1.2.1 This Dispatch Protocol aims to define the delineation of the functions and responsibilities between the *Market Operator* and the *System Operator* in respect to *dispatch* scheduling and implementation in the *WESM*.

1.2.2 More specifically, the objectives of this Dispatch Protocol are to:

- a. Establish the *WESM timetable* as provided for in *WESM Rules* Clause 3.4.3; and
- b. Establish the scheduling and *dispatch* procedures during normal system conditions and during *emergency* conditions that are consistent with the *WESM timetable* and the features of the *Market Management System (MMS)*. The procedures for *emergency* conditions include those that will apply during *market suspension* and restoration.

1.3 Scope

- 1.3.1 In accordance with *WESM Rules* Chapters 3 and 6, this Dispatch Protocol covers the following procedures for *dispatch* scheduling and implementation during normal system conditions and *emergency* conditions:
- a. Submission and processing of *bids* and *offers*;
 - b. *System Operator* data inputs and reports;
 - c. *Market projections*;
 - d. RTD scheduling;
 - e. Preparation and use of the *WESM merit order table (WMOT)*;
 - f. *Dispatch* implementation;
 - g. *Start-up* and *shutdown* of *generating units*;
 - h. Management of *must-run units (MRU)*;
 - i. Management of *excess generation*;
 - j. Scheduling and *dispatch* of *reserves*;
 - k. Post-*dispatch* reporting;
 - l. Procedures during *market intervention* and *market suspension*; and
 - m. Management of *load shedding* procedure.
- 1.3.2 Procedures for *load* forecasting are provided in the Load Forecasting Methodology Manual.
- 1.3.3 The procedures on *energy metering*, billing and settlements, as well as that involving fund administration, shall be covered in the Metering Standards and Procedures Manual, and Billing and Settlements Manual, respectively.
- 1.3.4 This Dispatch Protocol shall apply to the *Market Operator*, the *System Operator* and all *WESM Members*, including *intending WESM Members*, and participants in the electric power industry.
- 1.3.5 This Dispatch Protocol shall apply in the *grids* where the *WESM* is in operation.

SECTION 2 DEFINITIONS, REFERENCES AND INTERPRETATION

2.1 Definitions

- 2.1.1 Unless otherwise defined in this section or the context provides otherwise, the terms used in this *Market Manual* shall bear the same meaning as defined in the *WESM Rules*.
- 2.1.2 The following words and phrases as used in this *Market Manual* shall have the following meaning:
- a. **Automatic Load Dropping (ALD).** The process of automatically and deliberately removing pre-selected *loads* from a *power system* in response to an abnormal condition in order to maintain the integrity of the system. It can be classified as: 1) Under *frequency* Load Shedding (UFLS); and 2) Under-voltage Load Shedding (UVLS).

- b. **Availability.** The duration of time over a specified period that a plant/unit is ready to be in service or operational.
- c. **Bid.** Pertains to a tender of a *load customer* in the *WESM*.
- d. **Capability.** Highest power that a specified *generating unit* can deliver and sustain whenever called upon.
- e. **Cascading Outages.** The uncontrolled successive loss of system elements triggered by an incident at any location.
- f. **Contingency.** The *outage* of one component of the *grid* that cannot be predicted in advance which excludes scheduled maintenance.
- g. **Demand Control.** The reduction in demand for the control of *frequency* when the *grid* is in an *emergency state*. This includes *automatic load dropping*, *manual load dropping*, demand reduction upon instruction by the *System Operator*, demand disconnection initiated by users, *customer demand management*, and voluntary *load curtailment*.
- h. **Demand Control Imminent Warning.** A warning from the *System Operator*, not preceded by any other warning, which is issued when demand reduction is expected within thirty (30) minutes.
- i. **Disturbance.** An unplanned event that produces an abnormal system condition.
- j. **Frequency control.** A strategy used by the *System Operator* to maintain the *frequency* of the *grid* within the limits prescribed by the *Grid Code* by the timely use of *reserves* and *demand control*.
- k. **Generator.** *Generation Company*.
- l. **Load shedding.** The reduction or disconnection of *load* from the system as exercised by the *System Operator* in response to the following:
 - i. An overall shortage of *energy* at a *node* or in a region specified in the *market network model*;
 - ii. A severe under-voltage or *voltage instability* at one or more *nodes*; or
 - iii. Other network conditions, as determined by the *System Operator* in accordance with the procedures established under the *Grid Code* and the *Distribution Code*.
- m. **Manual Load Dropping.** The process of manually and deliberately removing pre-selected *loads* from a *power system* in response to an abnormal condition in order to maintain the integrity of the system.
- n. **Market Management System (MMS).** The infrastructure that supports the operations of the *WESM* and which includes functionalities that support the processes set out in this *Market Manual*.

- o. **Maximum available capacity.** Equal to the registered maximum capacity (Pmax) of the (aggregate) unit less forced unit *outages*, scheduled unit *outages*, de-rated capacity due to *technical constraints* and weather disturbance that cause damage to the unit or that would otherwise limit its ability to inject power to the *grid*. For co-generation systems, the *maximum available capacity* is further determined by taking into account the equivalent power of the thermal *energy* extraction by the *energy* host and *technical constraints*.
- p. **MMS-Market Participant Interface (MPI).** Refers to the user terminal where *Trading Participants* can submit *bids* and *offers* as well as retrieve or receive information on *WESM* operations, further described in Section 5.
- q. **Multiple Outage Contingency.** An event caused by the failure of two or more components of the *grid* including *generating units*, *transmission lines*, and transformers.
- r. **Offer.** Also refers to a *Market Offer*.
- s. **Operating margin.** The available generating capacity in excess of the sum of the system demand plus losses within a specified period of time.
- t. **Preferential Dispatch Units.** *Must dispatch generating units and priority dispatch generating units.*
- u. **Primary Reserve.** Synchronized generating capacity that is allocated to stabilize the system *frequency* and to cover the loss or failure of a synchronized *generating unit* or a *transmission line* or the power import from a single circuit interconnection, as defined in the *Grid Code*. Also referred to as *contingency reserves*.
- v. **Real-Time Dispatch.** Otherwise known as RTD. It is the *dispatch schedule* which determines the target loading of facilities at the end of the *dispatch interval*. The RTD calculates the *ex-ante nodal energy dispatch prices*.
- w. **Red Alert.** An alert issued by the *System Operator* when the *Primary Reserve* is zero, a *generation* deficiency exists, or there is critical loading or imminent overloading of *transmission lines* or equipment.
- x. **Secondary Reserve.** Synchronized generating capacity that is allocated to restore the system *frequency* to the nominal *frequency* of 60Hz, as defined on the *Grid Code*. Also referred to as *regulating reserves*.
- y. **Security.** The ability of the electric system to withstand sudden disturbances such as electric short circuits or unanticipated loss of system elements.
- z. **Self-scheduled nomination.** Nominations of *loading levels* by Non-Scheduled *Generation Companies* and *projected outputs* of *Generation Companies* with *must dispatch generating units* and *priority dispatch generating units*.
- aa. **Shutdown.** The condition of the equipment when it is de-energized or disconnected from the system.

- bb. **Stability.** Ability of the dynamic components of the *power system* to return to a normal or stable operating point after being subjected to some form of change or disturbance.
- cc. **Start-up.** The synchronization of a *generating unit* to the *grid* from its *outage* state (closing of *generator* breakers).
- dd. **System Integrity Protection Scheme (SIPS).** A protection system that is designed to detect abnormal or predetermined system conditions, and take automatic corrective actions.
- ee. **System Operator System Advisories.** Messages issued by the *System Operator* depicting particular issues regarding existing or anticipated status of the *power system*.
- ff. **System Snapshot.** Otherwise known as EMS Snapshot. The *system snapshot* contains MW loadings of *generators* and *loads*. The *system snapshot* also indicates connection status of the *power system*.
- gg. **Technical Constraint.** Refers to plant equipment-related failure, limitations encountered during *start-up/shutdown* procedure, effects of ambient temperature and resource-related *constraints* due to the following: (a) water elevation and diversion requirements for domestic or irrigation use for hydro plants; (b) steam quality (chemical composition, condensable and non-condensable gases, steam pressure and temperature) for geothermal plants; (c) unavailability of fuel resources that are not within the control of the *Generation Company* for biomass power plants; and (d) steam flow limitations, station *load*, and electricity demand of its *energy* host, in the case of the co-generation systems.
- hh. **Tertiary Reserve.** Capacity used in order to replenish the *Secondary Reserve* and for such other cases, as defined in the *Grid Code*.
- ii. **Voltage Control.** Any action undertaken by the *System Operator* or user to maintain the *voltage* of the *grid* within the limits prescribed by the *Grid Code* such as, but not limited to, adjustment of *generator* reactive output, adjustment in transformer taps or switching of capacitors or reactors.
- jj. **Voltage Instability.** A condition that results in *grid voltages* that are below the level where *voltage control* equipment can return them to the normal level.
- kk. **Voltage Sag.** A short-duration *voltage* variation where the RMS value of the *voltage* decreases to between 10 percent and 90 percent of the nominal value.

2.2 References

This Dispatch Protocol should be read in association with Chapter 3 and Chapter 6 of the *WESM Rules* and other *Market Manuals*, including but not limited to the reference documents listed in the Reference Documents table. Other references are also stated in relevant sections of this Dispatch Protocol.

2.3 Interpretation

The rules on interpretation set out in Chapter 9 of the *WESM Rules*, as these may be amended from time to time, shall govern the interpretation of this Dispatch Protocol.

SECTION 3 RESPONSIBILITIES

3.1 Market Operator

3.1.1 The *Market Operator* is responsible for the administration of the Wholesale Electricity Spot Market (*WESM*) in accordance with the *WESM Rules*. Among other functions, it is responsible for determining the *dispatch schedule* of all facilities in the *WESM*, which schedule shall be submitted to the *System Operator*¹.

3.1.2 In administering the operations of the *WESM*, the *Market Operator* shall carry out its functions by performing and complying with the obligations and procedures set out in this Dispatch Protocol.

3.1.3 The *Market Operator* is responsible for the development of procedures, processes and systems relevant to its functions contained in this *Market Manual* as well as the regular review of this *Market Manual* to ensure consistency with the *WESM Rules*.

3.2 System Operator

3.2.1 The *System Operator* shall be responsible for the implementation of the *dispatch schedule* as provided by the *Market Operator* and shall operate the *power system* in accordance with the *WESM Rules*, the *Grid Code* and other related rules in relation to the *security and reliability guidelines*. Its primary responsibilities include providing *central dispatch* to all *generation facilities* and *loads* connected, directly and indirectly, to the *transmission system* in accordance with the *dispatch schedule* submitted by the *Market Operator*².

3.2.2 The *System Operator* shall carry out its functions by performing and complying with the procedures and obligations set out in this Dispatch Protocol.

3.2.3 The *System Operator* is responsible for the development of procedures, processes and systems relevant to its functions contained in this *Market Manual*. Also, the *System Operator* shall regularly review its internal processes to ensure consistency with this *Market Manual*.

3.3 Trading Participants and other WESM Members

3.3.1 All *Trading Participants* and other *WESM Members* shall comply with the *timetable* and procedures for scheduling and *dispatch* that are set out in this Dispatch Protocol as such procedures apply to them. They shall ensure that their respective internal

¹ *WESM Rules* Clause 1.3.1

² *WESM Rules* Clause 1.3.3

processes, systems and infrastructure, as well as their protocols with their counterparties, are compliant with this Dispatch Protocol.

- 3.3.2 *Scheduled Generation Companies* are required to operate their *generating units* in accordance with the scheduling and *dispatch* procedures described in Chapter 3 of the *WESM Rules*³.
- 3.3.3 *Trading Participants* are responsible for the actions of any person or entity acting for or in their behalf, as such actions are considered the actions of the *Trading Participant*⁴.

SECTION 4 WESM TIMETABLE

4.1 Background

- 4.1.1 *WESM Rules* Clause 3.4.3.1 requires that the *Market Operator* shall operate the *spot market* in accordance with the *timetable*. The *timetable* is to be maintained, published and continuously updated by the *Market Operator*, as directed in *WESM Rules* Clause 3.4.3.3. *WESM Rules* Clause 3.4.3.4 further directs that changes on the *timetable* and related procedures shall be approved by the DOE in accordance with the rules change process set out in Chapter 8 of the *WESM Rules*.
- 4.1.2 The schedules and procedures for the following processes are required, under *WESM Rules* clause 3.4.3.2, to be included in the *WESM timetable*:
- Determining and publishing *week-ahead projections* for each hour including the precise specification of the *market horizon* to be used for such projections;
 - Determining and publishing *day-ahead projections* for each hour including precise specification of the *market horizon* to be used for such projections;
 - Determining and publishing *hour-ahead projections* for each *dispatch interval* including precise specification of the *market horizon* to be used for such projections;
 - Submitting *offers, bids* and data;
 - Determining and publishing *load forecasts, real-time dispatch schedules*, and market prices; and
 - If necessary, for any other action to be taken by the *Market Operator*, the *System Operator* or any *WESM Member* during the operation of the *spot market*.
- 4.1.3 The schedules and procedures presented in this Dispatch Protocol are those prepared and maintained pursuant to the foregoing requirements of the *WESM Rules*. The schedules are as presented in this Section while the procedures are set out in other sections of this Dispatch Protocol.
- 4.1.4 The Market Operator shall periodically review and update, if necessary, the WESM Timetable.

³ *WESM Rules* Clause 2.3.1.8

⁴ *WESM Rules* Clause 7.2.6

4.2 Scope of the WESM Timetable

4.2.1 The *WESM Timetable* is the overall schedule of market activities under different time frames of operations as embodied in the *WESM Rules*. These activities are presented in the *timetable* in four (4) different but inter-related time frames, as follows:

- a. *Week-ahead projection (WAP)*
- b. *Day-ahead projection (DAP)*
- c. *Hour-ahead projection (HAP)*
- d. *Real-time dispatch (RTD)*

4.3 Week-Ahead Projection (WAP)

4.3.1 WAP is executed daily and covers the hourly intervals starting from the next day (D+1) until the seventh day from Day “D” (D+7).

4.3.2 The following activities shall be performed for the WAP, within the time specified, using inputs for the covered study period of that specific WAP run:

Table 1. WAP Timeline

Time	Activity	Responsible Party
Before 0845H	Submit the most recent <i>self-scheduled nominations, bids and offers</i> for all relevant hours of the WAP run	<i>Trading Participants</i>
Before 0900H	Provide updates on the following, if any: 1. <i>Outage Schedules</i> 2. <i>Contingency List</i> 3. <i>Over-riding Constraints</i> 4. <i>Reserve Requirements</i>	<i>System Operator</i>
Before 0900H	Submit <i>load forecast</i> for the covered period	<i>Market Operator</i>
0900H	Execute WAP	<i>Market Operator</i>
Before 1100H	Publish WAP Results in the <i>MPI</i>	<i>Market Operator</i>
	Transmit WAP Results to <i>System Operator</i>	<i>Market Operator</i>

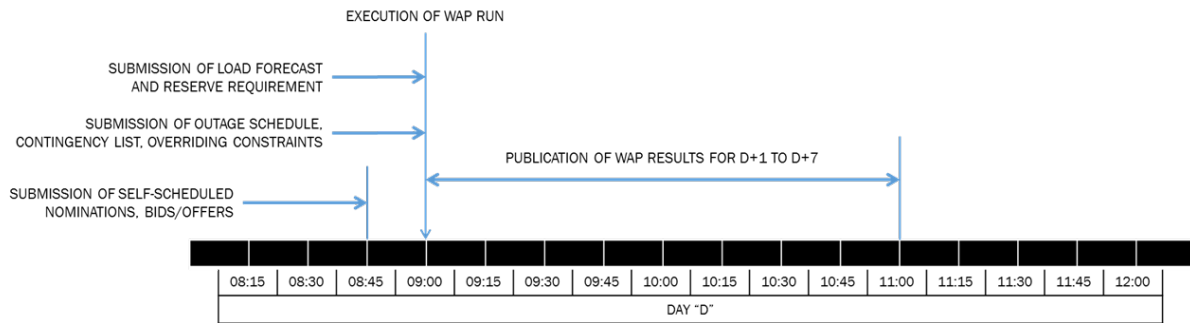
Figure 2. WAP Timeline

4.4 Day-Ahead Projection (DAP)

4.4.1 DAP is executed every hour and covers the hourly intervals starting from the current hour of the current day until either 2400H of the same day (for DAP runs before 12:00 NN) or 2400H of the next day (for DAP runs starting at 12:00 NN).

4.4.2 The activities that shall be performed for the DAP, within the time specified, using inputs for the covered study period of that specific DAP run, are provided in Table 2. The covered periods for all DAP runs within a day are provided in Table 3.

Table 2. DAP Timeline

Time	Activity	Responsible Party
Before [STPH1* - 10 minutes]	Submit the most recent <i>self-scheduled nominations, bids and offers</i> for all relevant hours of the DAP run	<i>Trading Participants</i>
Before [STPH1 + 1 minute]	Provide updates on the following, if any: <ol style="list-style-type: none"> 1. <i>Outage Schedules</i> 2. <i>Contingency List</i> 3. <i>Over-riding Constraints</i> 4. <i>Reserve Requirements</i> 5. <i>Real-time system snapshot</i> 6. <i>VRE Aggregated Generation Forecasts</i> 7. <i>Forecasts on the loading levels of Must dispatch generating units</i> 	<i>System Operator</i>
Before [STPH1 + 1 minute]	Submit <i>load forecast</i> for the covered period	<i>Market Operator</i>
[STPH1 + 1 minute]	Execute DAP	<i>Market Operator</i>
Before [STPH1 + 25 minutes]	Publish DAP Results in the <i>MPI</i>	<i>Market Operator</i>
	Transmit DAP Results to <i>System Operator</i>	<i>Market Operator</i>

* STPH1 refers to the Start Time of the first Projected Hour (1) covered by the DAP run. For example, the Projected Hour of 0900H has a start time of 08:00 AM and an end time of 09:00 AM.

Table 3. DAP Run Covered Period

DAP RUN TIME		COVERED PERIOD				NO. OF HOURS
		FROM		TO		
TIME	DAY	TIME	DAY	TIME	DAY	
0:00	D	1:00	D	0:00	D+1	24
1:00	D	2:00	D	0:00	D+1	23
2:00	D	3:00	D	0:00	D+1	22
3:00	D	4:00	D	0:00	D+1	21
4:00	D	5:00	D	0:00	D+1	20
5:00	D	6:00	D	0:00	D+1	19
6:00	D	7:00	D	0:00	D+1	18
7:00	D	8:00	D	0:00	D+1	17
8:00	D	9:00	D	0:00	D+1	16
9:00	D	10:00	D	0:00	D+1	15
10:00	D	11:00	D	0:00	D+1	14
11:00	D	12:00	D	0:00	D+1	13
12:00	D	13:00	D	0:00	D+2	36
13:00	D	14:00	D	0:00	D+2	35
14:00	D	15:00	D	0:00	D+2	34
15:00	D	16:00	D	0:00	D+2	33
16:00	D	17:00	D	0:00	D+2	32
17:00	D	18:00	D	0:00	D+2	31
18:00	D	19:00	D	0:00	D+2	30
19:00	D	20:00	D	0:00	D+2	29
20:00	D	21:00	D	0:00	D+2	28
21:00	D	22:00	D	0:00	D+2	27
22:00	D	23:00	D	0:00	D+2	26
23:00	D	0:00	D+1	0:00	D+2	25

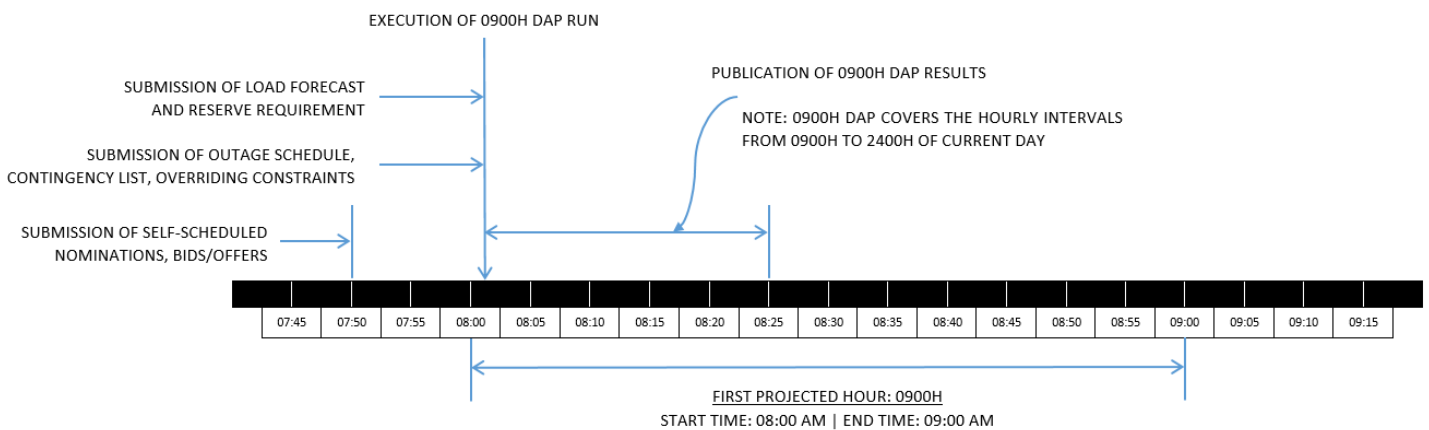
Figure 3. DAP Timeline

4.5 Hour-Ahead Projection (HAP)

4.5.1 HAP is executed at the same *frequency* as the RTD in Section 4.6, and covers all *dispatch intervals* in one hour, starting from the next *dispatch interval*.

4.5.2 The following activities shall be performed for the HAP, within the time specified, using inputs for the covered study period of that specific HAP run.

Table 4. HAP Timeline

Time	Activity	Responsible Party
Before [STDI1** – 9 minutes]	Submit the most recent <i>self-scheduled nominations, bids and offers</i> for all relevant hours of the HAP run	<i>Trading Participants</i>
Before [STDI1 – 7 minutes]	Provide updates on the following, if any: 1. <i>Outage Schedules</i> 2. <i>Contingency List</i> 3. <i>Over-riding Constraints</i> 4. <i>Reserve Requirements</i> 5. <i>Real-time system snapshot</i>	<i>System Operator</i>
Before [STDI1 – 7 minutes]	Submit <i>load forecast</i> for the covered period	<i>Market Operator</i>
[STDI1 – 7 minutes]	Execute HAP	<i>Market Operator</i>
Before [STDI1 – 2 minutes]	Publish HAP Results in the <i>MPI</i>	<i>Market Operator</i>
	Transmit HAP Results to <i>System Operator</i>	<i>Market Operator</i>

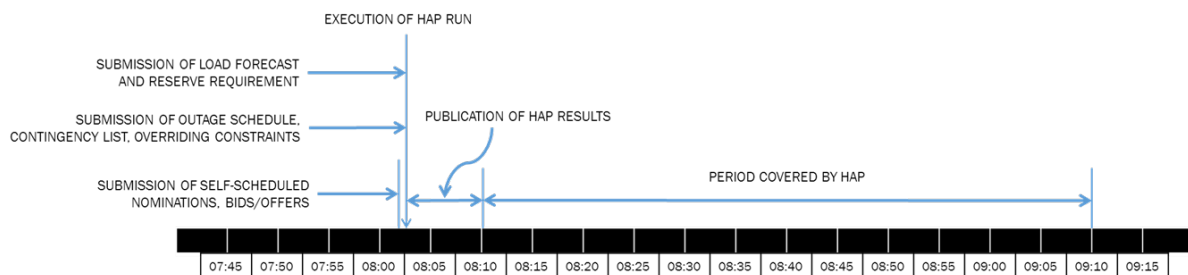

Figure 4. HAP Timeline

** STDI1 refers to the Start Time of the first *dispatch interval* (1) covered by the HAP run. For example, the 0815H *dispatch interval* has a start time of 08:10 AM and an end time of 08:15 AM. And if this is the first *dispatch interval* of the HAP run, then it will cover the period until 09:10 AM.

4.6 Real-Time Dispatch Schedule (RTD)

4.6.1 RTD runs produce results for each *dispatch interval*.

4.6.2 The following activities shall be performed for the RTD, within the time specified, using inputs for the covered study period of that specific RTD run:

Table 5. RTD Timeline

Time	Activity	Responsible Party
Before [STDI ^{***} – 9 minutes]	Submit <i>self-scheduled nominations, bids and offers</i> for all relevant hours of the RTD run	<i>Trading Participants</i>
Before [STDI – 7 minutes]	Provide updates on the following, if any: 1. <i>Outage Schedules</i> 2. <i>Contingency List</i> 3. <i>Over-riding Constraints</i> 4. <i>Reserve Requirements</i> 5. <i>Real-time system snapshot</i>	<i>System Operator</i>
Before [STDI – 7 minutes]	Submit <i>load forecast</i> for the relevant <i>dispatch interval</i>	<i>Market Operator</i>
[STDI – 7 minutes]	Execute RTD	<i>Market Operator</i>
Before [STDI – 2 minutes]	Publish RTD Results in the <i>MPI</i>	<i>Market Operator</i>
	Transmittal of <i>Energy and Reserve Schedules</i> , and <i>WESM Merit Order Table</i> to the <i>System Operator</i>	<i>Market Operator</i>

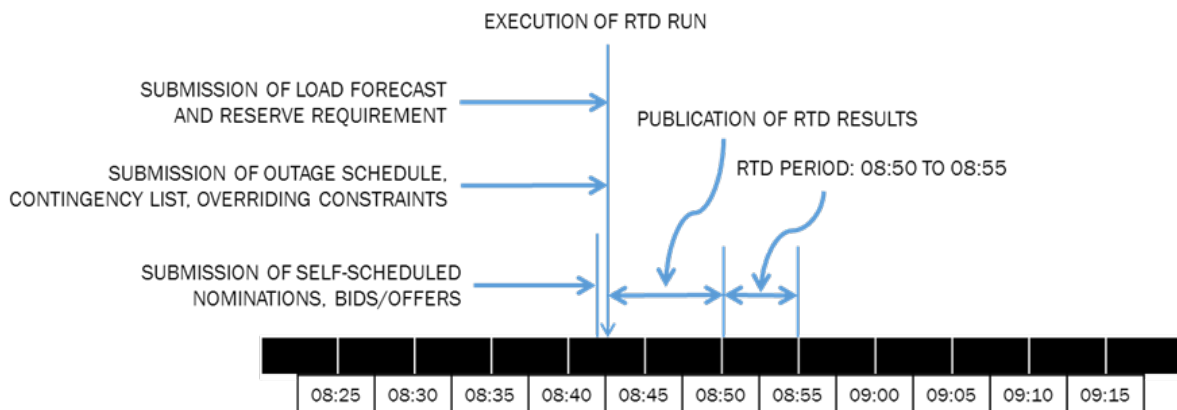

Figure 5. RTD Timeline

*** STDI refers to the Start Time of the relevant *dispatch interval*.

SECTION 5 MARKET INFRASTRUCTURE
--

5.1 Background

- 5.1.1 The *market projections* and *real-time dispatch market runs* described in this Dispatch Protocol shall be carried out using the *Market Management System (MMS)*, which is the infrastructure that supports the operations of the *WESM*.
- 5.1.2 The week-ahead, day-ahead, and hour-ahead projections and the *real-time dispatch market runs* make use of the *market dispatch optimization model (MDOM)*, where all inputs coming from the *Trading Participants*, the *System Operator*, and the *Market Operator* are retrieved to produce a solution according to the principles set forth in the *Price Determination Methodology Manual*.
- 5.1.3 The *Market Operator's MMS* shall obtain real-time data from the *System Operator's Energy Management System (EMS)* and from other *Network Service Providers*, through a data exchange facility.
- 5.1.4 Other submissions and transmittal of data or information between the *Market Operator* and the *System Operator*, or other *Network Service Providers*, shall be through a dedicated data exchange facility.
- 5.1.5 The *MMS* includes the *Market Participant Interface (MPI)* to and from which the *Trading Participants* submit required data to the *Market Operator* and access data on market results, advisories and other information notified and published to it in accordance with this Dispatch Protocol.
- 5.1.6 The *Market Operator's MMS* involves a variety of other *energy management* and *market applications* to further increase the efficiency in *WESM* operations.
- 5.1.7 The following figure shows an overall picture of the major applications within the *MMS*.

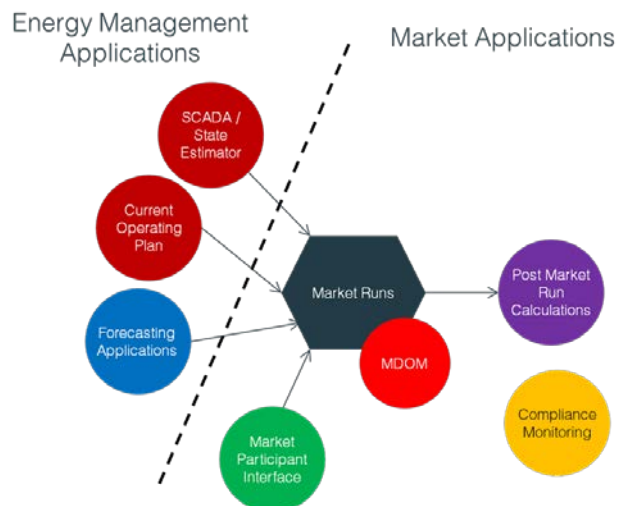

Figure 6. Overview of MMS Infrastructure

- 5.1.8 Publications required by this Dispatch Protocol are made available in the *market information website*, which includes a portal accessible only to registered *WESM Members*.

5.2 Overview on the Energy Management Applications

- 5.2.1 The *Market Operator* shall regularly obtain real-time data from the *System Operator* at a shorter duration than the *dispatch interval* through an Inter-Control Center Communications Protocol (ICCP). Likewise, the *Market Operator* shall ensure timely submission of RTD schedule including *WMOT* on or before the start of the *dispatch interval* via the most efficient facility in transferring data to the *System Operator*.
- 5.2.2 The *Market Operator* may then use an application to generate state-estimated values from the real-time data obtained from the *System Operator*. State estimation aims to provide a more accurate representation of the current state of the *power system*. State-estimated values are eventually used by the *hour-ahead projection* and *real-time dispatch*.
- 5.2.3 The *System Operator* shall also submit its *over-riding constraint* inputs to the MDOM via the Current Operating Plan using the most efficient facility in transferring data to *Market Operator*.
- 5.2.4 The *Market Operator* shall maintain a *load* forecasting application that will create *load forecasts* for the *market projections* and the *real-time dispatch*.

5.3 Overview on the Market Applications

- 5.3.1 *Trading Participants* shall submit *self-scheduled nominations, bids, and offers* through the *MMS-Market Participant Interface (MPI)*. The *MPI* also provides user interfaces for accessing market results, reports, and information concerning their real-time status in accordance with the *dispatch conformance standards*.
- 5.3.2 The Market Applications generate results for the *market projections* and the *real-time dispatch* in accordance with the *WESM Timetable*.
- 5.3.3 The results of the *market projections* and the *real-time dispatch* are obtained using the MDOM.
- 5.3.4 The results of the *real-time dispatch* are further subject to pricing corrections near real-time using the application for post-market run calculations.
- 5.3.5 The *Market Operator* shall also maintain a facility for monitoring the compliance of *Trading Participants* to the *dispatch conformance standards*.

SECTION 6 BIDS, OFFERS AND DATA SUBMISSION AND PROCESSING**6.1 Background**

- 6.1.1 *WESM Rules* Clause 3.5 provides for the rules in respect of the submission of *market offers*. Under said section, each *Scheduled Generation Company* including those with *bilateral contracts* shall submit standing profiles of *market offers* for each of its *scheduled generating units* for each one (1) hour interval. *Non-scheduled Generation Companies*, meanwhile, shall submit standing profiles of the schedule of the *loading levels* for each of its *non-scheduled generating units*, while *Generation Companies* in respect of their *Must dispatch generating units* and *priority dispatch generating units* shall submit standing *projected outputs* of their *generating units*.
- 6.1.2 Qualified *customers* or those registered by the *Market Operator* as *dispatchable load* may submit standing profiles of *demand bids* in respect of each one (1) hour interval for each of its registered scheduled *load facilities* for each *trading day* of the week in accordance with the *timetable*. Submission of *demand bids* are provided for in *WESM Rules* Clause 3.5.6.
- 6.1.3 Each *Scheduled Generation Company* registered as an *ancillary services provider* shall submit standing profiles of *reserve offers* for each of its relevant *reserve facilities* in respect of a *reserve region*. *Customers* registered as *ancillary services provider*, meanwhile, may submit standing profiles of *reserve offers* for their *interruptible load facilities*. In either case, the submissions are made for each one (1) hour interval. Submission of *reserve offers* are provided for in *WESM Rules* Clauses 3.5.7 and 3.5.8.
- 6.1.4 Standing profiles of the *self-scheduled nominations, bids and offers* are converted to a daily working profile of the *self-scheduled nominations, bids and offers*. Such working profiles are used by the *market projections* and the *real-time dispatch*.
- 6.1.5 Revision of the standing and daily working profiles representing *market offers and bids* is provided for in *WESM Rules* Clause 3.5.11. *Trading Participants* may revise any of their standing and daily working profiles representing *self-scheduled nominations*. Such revisions should take into consideration the *Open Market Window* and the *timelines*.
- 6.1.6 *WESM Rules* Clause 3.5.11.2 directs *Generation Companies* that have submitted *self-scheduled nomination* of their *non-scheduled generating units* to revise the same if it reasonably expects that any of its anticipated *loading levels* will differ materially from those previously submitted.
- 6.1.7 *WESM Rules* Clause 3.5.11.5 requires *Trading Participants* to revise their *bids or offers* if they no longer represent a reasonable estimate of either the expected *availability* for the *dispatch interval* of the relevant *generating unit* or *scheduled load* or the *demand bids or offers* likely to apply in the *real-time dispatch* optimization for the *dispatch interval*.
- 6.1.8 Pursuant to *WESM Rules* Clause 3.5.11.6, *Trading Participants* that cancel their *bids or offers*, or submit *bids or offers* less than the registered capacity or *maximum*

available capacity of their *facility* or *generating unit* are required to provide information on the reasons or circumstances of such cancellation or submission.

- 6.1.9 *Trading Participants* are also required to immediately notify the *System Operator* and the *Market Operator* of any circumstances which threaten a significant probability of material adverse change in the state of their facilities. A non-exhaustive list of events that will be deemed to be or to cause material adverse change is required to be published. In compliance with the foregoing, a non-exhaustive list is provided under Section 6.14 of this *Market Manual* pursuant to *WESM Rules* Clause 3.5.11.8.

6.2 Scope

- 6.2.1 This Section sets out the procedures for submitting, revising and processing *bids, offers, and self-scheduled nominations* for *energy* and *reserve* in the *WESM*. *Bids, offers, and self-scheduled nominations* submitted shall be used in the pre-dispatch *market projections* (i.e., *hour-ahead, day-ahead* and *week-ahead projections*) and *real-time dispatch market runs*.
- 6.2.2 The requirements and conditions for a valid cancellation of *self-scheduled nominations, bids, and offers* are also set out in this Section.

6.3 Responsibilities

- 6.3.1 *Trading Participants* are responsible for timely submission of *self-scheduled nominations, bids, and offers* and associated data submissions which are compliant with the requirements of the *WESM Rules*, this Dispatch Protocol and other relevant *Market Manuals*, as well as to the format and procedures required for submission to the *MMS*. They are also responsible for ensuring that their facilities are able to access the Market Participant Interface of the *MMS* at all times.
- 6.3.2 The *Market Operator* shall maintain an MPI through which access to the *MMS* is provided to the *Trading Participants*.

6.4 Categories of Self-scheduled Nominations, Bids, and Offers

- 6.4.1 The *self-scheduled nominations, bids, and offers* that can be submitted in the *WESM* are as follows:
- a. Real-time *market offers* for *scheduled generating units* of *Scheduled Generation Companies*;
 - b. *Operating reserves offers* for certified *ancillary service providers*;
 - c. *Demand bids* from customer *Trading Participants*; and
 - d. *Self-scheduled nominations*
 - i. Schedule of *loading levels* (i.e. *energy* quantities only) for *non-scheduled generating units* of non-scheduled *Generation Companies*; and
 - ii. *Projected output* (i.e. *energy* quantities only) of *Generation Companies* with *must dispatch generating units* and *priority dispatch generating units*

6.5 Requirements for Self-scheduled Nominations, Bids, and Offers

- 6.5.1 Each daily working profile representing a *self-scheduled nomination, bid, or offer* is in respect of one (1) registered resource. For example, if the *Trading Participant* has six registered resources, that *Trading Participant* will submit six (6) separate daily working profiles representing *self-scheduled nominations, bids, or offers*, one for each registered resource.
- 6.5.2 Each *self-scheduled nomination, bid, or offer* must be compliant with and must contain the information required in Section 6.9 of this *Market Manual*.
- 6.5.3 Each daily working profile representing *bids or offers* for the 24 hourly intervals of a *trading day*, wherein each of the 24 hourly intervals can have different price curves. Price curves represent the Price and MW Quantity Pairs bid or offered for a certain resource.
- 6.5.4 Each daily working profile representing *self-scheduled nominations* can consist of a complete set or a subset of the *self-scheduled nominations* for all *dispatch intervals* of a *trading day*, wherein each *dispatch interval* can have different MW nominations.
- 6.5.5 The *self-scheduled nominations, bids, and offers* shall be submitted through the *MPI* provided by the *Market Operator* in the format set out in this Section.
- 6.5.6 Submissions or revisions to *self-scheduled nominations, bids, or offers* for a particular *dispatch interval* shall consider the timelines set out in the *WESM Timetable* in Section 4, as well as the Open Market Window in Section 6.6 .
- 6.5.7 Each of the submitted or revised *self-scheduled nominations, bids, or offers* is validated against the validation rules.

6.6 Open Market Window

- 6.6.1 The Open Market Window covers the current day up until the next seven (7) days. The covered dates are the trading dates where *self-scheduled nominations, bids, or offers* can be created, submitted, revised, or canceled. *Trading Participants* can only submit *self-scheduled nominations, bids, or offers* for *trading days* that are within the Open Market Window.
- 6.6.2 *Self-scheduled nominations, bids, or offers* for the previous seven (7) days are made available so that it can be retrieved for re-use for *trading days* within the Open Market Window.
- 6.6.3 *Self-scheduled nominations, bids, or offers* that passed validation (“valid” *self-scheduled nominations, bids, or offers*) submitted within the Open Market Window can be cancelled, changed, or retrieved.
- 6.6.4 The most recently submitted *self-scheduled nominations, bids, or offers* which passed validation shall be used for the *market projection* or *real-time dispatch market runs*.

- 6.6.5 *Self-scheduled nominations, bids and offers* that passed validation and were accepted for the *real-time dispatch market runs* are binding and shall be considered in the real-time *ex-ante* scheduling and pricing processes.

6.7 Market Participant Interface

- 6.7.1 Registered *Trading Participants* shall have an access to the *MMS* through an *MPI*, which shall be used by *Trading Participants* for submitting their *self-scheduled nominations, bids and offers*, and other data in the *WESM*, as well as to access previously submitted *self-scheduled nominations, bids, and offers*, and other market information or advisories published in the form of system messages and market status displays.
- 6.7.2 Specific URLs to access the *MPI* shall be advised by the *Market Operator* to the *Trading Participants* from time to time.

6.8 Types of Self-scheduled Nominations, Bids, and Offers

- 6.8.1 Through the *MPI*, a *Trading Participant* can create and submit Standing Profile or a Daily Working Profile for a specific resource.
- 6.8.2 **Standing Profiles.** Standing *self-scheduled nominations, bids or offers* are standard bid profiles for a given type of day of a week. A Standing Bid is submitted to ensure a default bid is used if no Daily Bid is submitted. A Standing Bid is submitted in the same way as a Daily Bid except that the bid is identified as “Standing” and that a “Day Type” is identified.

- a. Standing *self-scheduled nominations, bids or offers* for the following day types can be submitted:

Type of Day	Label (in <i>MMS</i>)
Holiday	HOL
Specific day of the week	MON. . . . SUN
All days in a week	ALL

- b. The order of precedence is HOL > MON.....SUN > ALL. Thus, a *self-scheduled nomination, bid or offer* submission for day type “HOL” will supersede bids for any of the other day types.
- c. A submitted and validated standing *self-scheduled nomination, bid or offer* becomes a standing *self-scheduled nomination, bid or offer* profile of a resource or power *facility* starting on the seventh day after the *self-scheduled nomination, bid or offer* is submitted. For example, a Standing Bid submitted on 1 June will become effective on 8 June. Each day onwards, the standing *self-scheduled nomination, bid or offer* profile for that resource shall be converted to a regular bid subject to validation. Conversion of standing *self-scheduled nomination, bid or offer* is carried out in the *MMS* prior to a relevant *market run* (i.e., WAP, DAP, HAP or RTD).

- d. The standing *self-scheduled nomination, bid or offer* that passed validation stays in effect until superseded.

6.8.3 **Daily Working Profile.** A daily working profile represents the *self-scheduled nominations, bids, or offers* for each hour or *dispatch interval* of a specific calendar date. Daily working profiles that are submitted and passed validation shall become effective immediately. A daily submission will supersede an existing daily submission.

6.9 Format and Contents of Submissions

6.9.1 *Self-scheduled nominations, bids or offers* are submitted to the MMS using the MPI through the following:

- a. MPI User Interface; or
- b. XML Bid Submission

6.9.2 *Trading Participants* shall provide the following information when submitting *market offers*:

- a. May include up to ten (10) *market offer* blocks per (aggregate) unit. The maximum combined capacity of *generation* and *reserve offers* must not be less than the *maximum available capacity* of the *generator*;
- b. Shall be for a minimum block size of one (1) MW;
- c. Shall have monotonically increasing prices, starting from zero *generation*;
- d. May include negative prices; and
- e. Shall include up to three (3) segments of *ramp rate* profiles for different quantity break-points. The ramp up/down rates shall range from the minimum to the maximum registered *ramp rates*.

6.9.3 *Trading Participants* shall provide the following information when submitting *battery energy storage system offers*:

- a. May include up to ten (10) *energy offer* blocks per (aggregate) unit. The maximum combined capacity of *generation* and *reserve offers* must not be less than the *maximum available capacity* of the *generator*;
- b. Shall be for a minimum block size of one (1) MW;
- c. Shall have monotonically increasing prices and quantity;
- d. May start from a negative quantity to represent its projected maximum consumption
- e. May include negative prices; and
- f. Shall include up to three (3) segments of *ramp rate* profiles for different quantity break-points. The ramp up/down rates shall be within the minimum and maximum registered *ramp rates*.

6.9.4 *Trading Participants* shall provide the following information when submitting *reserve offers*:

- a. A maximum response level for the relevant *reserve* category (MW);

- b. A maximum proportion of the forecast/*scheduled load*, which may be interrupted;
- c. Up to three (3) *reserve offer* blocks (MW/block);
- d. A minimum block size of one (1) MW; and
- e. Monotonically increasing prices.

6.9.5 *Trading Participants* shall provide the following information when submitting *demand bids*:

- a. Shall have up to 10 *bid* blocks per take-off point;
- b. Shall have a minimum block size of one (1) MW;
- c. Shall have monotonically decreasing prices;
- d. Shall start from a zero off-take;
- e. May have *bid* prices that are negative; and
- f. Shall include a validity period of *bids*.

6.9.6 *Trading Participants* shall provide a MW value to represent their *self-scheduled nomination* for their respective *preferential dispatch generating units* or *non-scheduled generating units*.

6.9.7 The *Market Operator* shall publish a document that will provide operational details on the submission of *self-scheduled nominations*, *bids*, and *offers* in the *market information website*.

6.10 Acknowledgement of Self-scheduled Nominations, Bids, and Offers

6.10.1 The *MPI* issues a unique Transaction ID for each daily working profile of *self-scheduled nomination*, *bid*, or *offer* submissions. The Transaction ID shall be attached to the daily working profile of *self-scheduled nomination*, *bid*, or *offer* data whether they are accepted or determined as an invalid.

6.10.2 For standing *self-scheduled nominations*, *bids*, or *offers* that are converted to a daily working profile, the submission will have the same transaction ID as when it was submitted as a standing *self-scheduled nominations*, *bids*, or *offers*.

6.10.3 The *MMS* keeps a database of valid, rejected, and invalid *self-scheduled nomination*, *bid*, and *offer* submissions.

6.11 Updating of Self-scheduled Nominations, Bids, or Offers

6.11.1 Within the Open Market Window, a *self-scheduled nomination*, *bid*, or *offer* may be updated or revised as often as the *Trading Participant* desires. Subject to the requirements set out in this Section for cancellation and revision of *bids*, previously submitted *self-scheduled nominations*, *bid*, or *offer* may be cancelled or revised within the Open Market Window.

6.11.2 To revise *self-scheduled nominations*, *bids*, or *offers*, previously submitted *self-scheduled nominations*, *bids*, or *offers* can be retrieved through the *MPI* which may then be updated, modified or cancelled.

6.11.3 *Self-scheduled nominations, bids, or offers* that are updated or revised will be submitted through the *MPI* following the same procedures for submission of *self-scheduled nominations, bids, or offers*. Such revised/updated submission will be subject to the same acknowledgement and validation process set out in this Section. Standing Bids which have been “converted” into a Daily Bid can be modified using the Daily Bid option.

6.11.4 Cancellation of previously submitted bids follows the same process as submission of *self-scheduled nominations, bids, or offers* above except that instead of “SUBMIT” entry in the *MPI*, a “CANCEL” entry is specified. The cancellation of a standing *self-scheduled nominations, bids, or offers* shall become effective after the seventh day from cancellation but the corresponding Standing Bid profile must be deleted immediately upon submission of the cancellation.

6.12 Validation of Self-scheduled Nominations, Bids, and Offers

6.12.1 *Self-scheduled nominations, bids, or offers* submissions shall be subject to the validation in the *MMS*.

6.12.2 **Syntax / Semantic Validation.** *Self-scheduled nominations, bids or offers* are validated for consistency with Section 6.9.1.

6.12.3 **Market-Based Validation.** *Self-scheduled nominations, bids or offers* are also validated based on consistency with Sections 6.9.2, 6.9.3, 6.9.4 and 6.9.5 as the case may be, registration data, and whether such are within the *offer* price floor and cap.

6.13 Revisions of Self-scheduled Nominations, Bids and Offers Based on Reasonable Estimates

Trading Participants shall revise their *self-scheduled nominations, bids, or offers*, if the *self-scheduled nominations, bids or offers* submitted no longer represent a reasonable estimate of either the following:

- a. The expected *availability* for the *dispatch interval* of the relevant *generating unit or scheduled load*; or
- b. The *loading level, projected output, bid or offer* likely to apply in the *real-time dispatch optimization* for the *dispatch interval*.

6.14 Report of Material Adverse Change in State of Trading Participant Facilities

6.14.1 *WESM Rules* Clause 3.5.11.7 requires *Trading Participants* to advise the *System Operator* and the *Market Operator* of any circumstances which threaten a significant probability of material adverse change in the state of their facilities in any *dispatch interval* of any *trading day* in the current week-ahead *market horizon*. *Trading Participants* will give notice to the *Market Operator* and the *System Operator* within the relevant *WESM timetable*.

6.14.2 After the occurrence of the significant event, *Trading Participants* are further required to submit a written report with supporting data to the *Market Operator*. The report is to be submitted within the following *trading day*.

- 6.14.3 To facilitate compliance by the *Trading Participants* with their reporting obligations, the *System Operator* and the *Market Operator*, at their discretion, establish separate facilities for submission of notices and reports and prescribe procedures for submission.
- 6.14.4 The following is a non-exhaustive list of the material adverse changes to be reported by the *Trading Participants*:
- a. Inadvertent omissions or cancellation of *self-scheduled nominations, bids, and offers* of significant quantity relative to the demand in the specific *dispatch interval* for which such *self-scheduled nominations, bids, or offers* apply.
 - b. Gross errors in the submission of *self-scheduled nominations, bids, or offers* by the *Trading Participants* which deviate from a reasonable estimate of the current state of its facilities or system.
 - c. Scheduled or forced *outages* of the system or facilities of a *Trading Participant* which may impede its ability to commit to its *self-scheduled nominations, bids, or offers* submission in the *WESM*.
 - d. Impending emergencies which may require the facilities or system of a *Trading Participant* to be operational or to *shutdown* to prevent any potential disaster or threat to human life or property.
 - e. Local or national calamities which may affect a significant portion of the system or facilities of a *Trading Participant*.
 - f. Labor and management conflict which may result in work stoppage and prevent the *Trading Participant* or significantly reduce its ability to participate in the *WESM*.
 - g. A significant event that is expected to cause the *Trading Participant* to cancel or revise its standing *self-scheduled nominations, bids or offers*, or to submit *offers* for *scheduled generating units* that are less than the registered maximum capacities of said units.

SECTION 7 SYSTEM OPERATOR INPUT DATA AND REPORTS

7.1 Background

- 7.1.1 *WESM Rules* Clause 3.5.3 provides the responsibility of the *System Operator* to submit to the *Market Operator* standing network data relating to all network elements which are included in the *market network model*. In this regard, *Network Service Providers* are required, under *WESM Rules* Clause 3.5.2 to submit to the *System Operator* standing network data relating to all network elements under its control, which the *Market Operator* shall include in the *market network model*. Data required to be submitted are set out in Appendix A2 of the *WESM Rules*.
- 7.1.2 The *System Operator* is also required under *WESM Rules* Clause 3.5.3.2 to advise the *Market Operator*, when necessary, of the need to vary the *market network model* employed for any *dispatch interval* to take account of information provided by *Network Service Providers*, as well as the need to apply or vary any *system security constraints*,

over-riding constraints or reserve requirement constraints to be applied in any *dispatch interval* to take into account current or projected system conditions.

- 7.1.3 The Price Determination Methodology approved for the *WESM* also provide for the input data required of the *System Operator* which shall be considered in the market scheduling and pricing processes.

7.2 Scope and Purpose

- 7.2.1 This Section contains the procedures that will be followed for the submission by the *System Operator* to the *Market Operator* of the data required for the market scheduling and pricing processes, as well as the submission of other *System Operator* data, report, messages and advisories.
- 7.2.2 The data and information requirements listed in this Section is a non-exhaustive list of the data required, and other information may also be required to be submitted under other *Market Manuals* and the *WESM Rules*. Where applicable and if not otherwise provided, the submission of such other data and information shall also follow the procedures set out in this Section.
- 7.2.3 Data and report submissions relevant to the scheduling and *dispatch of reserves* traded in the *WESM* are covered under Section 15 of this Dispatch Protocol.

7.3 Responsibilities

- 7.3.1 The *Market Operator* shall be responsible for:
- a. Providing and maintaining the data exchange and communication facilities it needs to ensure timely submission of *dispatch schedules* (RTD/HAP/DAP/WAP) and *WMOT*, messages and advisories transmitted by the *Market Operator* to the *System Operator* and *Trading Participants*; and
 - b. Ensuring that data inputs required of the *System Operator* are considered in the market *dispatch* optimization runs.
- 7.3.2 The *System Operator* shall be responsible for:
- a. Preparing the data and reports required to be submitted as set out in this Dispatch Protocol and relevant provisions of the *WESM Rules* and other *Market Manuals*, and for transmitting the same to the *Market Operator* in accordance with the schedules and procedures set out in this Section;
 - b. Providing and updating *contingency* lists and *outage* schedules through data exchange communication facility for a particular period; and
 - c. Ensuring with the *Market Operator* that the data exchange and communication facilities between *System Operator* and *Market Operator* are operating in normal condition for timely transmittal of data and report.
- 7.3.3 *Network Service Providers* shall ensure timely submission of requests and schedules for *outages* of their respective *transmission lines* and sub-station equipment to the *System Operator*.

7.3.4 The *Trading Participants* shall ensure timely submission to the *System Operator* of their requests and schedules for *outages* of their *generating units*, in accordance with the *Grid Code*.

7.4 Data and Report Requirements

7.4.1 **Market run data Inputs.** For each *dispatch interval*, the *System Operator* shall provide and update data, if necessary, which shall be used in the pre-dispatch projections and *real-time dispatch market runs*:

- a. *Outage* schedules
- b. *Contingency* lists
- c. *Over-riding constraints*
- d. *Reserve* requirements

7.4.2 The *System Operator* shall issue System Advisories to relevant agencies such as *DOE, ERC, Grid Management Committee (GMC)* and the *Market Operator* based on the following information:

- a. Alert Notices;
- b. Significant incidents; and
- c. Declaration of *market intervention* and *market suspension*.

7.5 Outage Schedules

7.5.1 The approved *outage* schedules that shall be provided by the *System Operator* to the *Market Operator* through data exchange communication facilities shall be for the following types of equipment:

- a. *Generating units*;
- b. *Transmission lines*; and
- c. Sub-station equipment

7.5.2 Only *outage* schedules inputted in the data exchange facility as provided by the *System Operator* shall be included in the *market dispatch optimization model (MDOM)* of the *Market Operator*.

7.6 Over-riding Constraints

7.6.1 The *MMS* provides a functionality that allows the *Market Operator* to make adjustments in the operating *constraints* of the *MDOM* for a particular period. Such adjustments or *over-riding constraints* in the *MDOM* are imposed by the *Market Operator*, in coordination with the *System Operator*.

7.6.2 The types of *over-riding constraints* that may be imposed in the *MDOM* include the following:

- a. *Security Limits* - The *System Operator* may impose *security limits* to override the *market offers* and address possible threats in *system security*.

- i. *Generation Limits* – involves the minimum and maximum operating limits for *generation*. *Security* limits for *generating units* shall also include scheduled *must-run units* in accordance with the selection criteria in section 17.2 of this Dispatch Protocol.
 - ii. *Branch Group Limits* – involves the maximum flow that may pass through a certain group of *transmission lines*
 - iii. *Transmission Limits* – involves the maximum flow that may pass through a specific line or transformer or *HVDC*
 - iv. Other types as may be recommended by the *System Operator*
- b. *Non Security Limits: Testing and commissioning*
- i. *Generating Unit Limitations*
 - ii. *Regulatory and Commercial Testing*
- 7.6.3 *Over-riding constraints* in the scheduling and *dispatch* of *generating units* qualifying as *must-run units* designated under Section 7.6.2 and Section 17, shall be compensated based on the mechanism set forth in the Price Determination Methodology Manual. *Over-riding constraints* for the scheduling and *dispatch* of *generating units* undergoing Regulatory and Commercial testing process shall be considered as price takers in the *WESM* for *generation* traded in the *spot market*.

7.7 Contingency List Requirements

- 7.7.1 The *security* and reliability of the *grid* shall be based on the single *outage contingency* (N-1) criterion. This criterion specifies that the *grid* shall continue to operate in the normal state following the loss of one *generating unit*, *transmission line*, or transformer.
- 7.7.2 The *contingency* list is a list of *transmission lines* identified by the *System Operator* for single *outage contingency* testing. The MDOM shall run *N-1 contingency* to ensure an RTD solution with a security-constrained *dispatch schedule*.
- 7.7.3 The identified *contingencies* for a *dispatch interval* shall conform to the provisions of the *WESM* System Security & Reliability Guidelines.
- 7.7.4 The default *contingency* list contains the definition of credible *contingencies* as provided by the *System Operator* (i.e. pre-defined *outage* scenarios) and each *contingency* event shall be loaded into the *MMS* database of the *Market Operator*. The MDOM solution shall provide an RTD which is a security-constrained *dispatch schedule*.
- 7.7.5 The *System Operator* shall consider the following when preparing the *contingency* list:
- a. Loading limits of *transmission lines*, transformers and *generating units*;
 - b. Single circuit *outage* (N-1) *contingency* including loss of Interconnection;
 - c. Selective multiple circuit *outage* with corresponding System Integrity Protection Scheme (SIPS); and
 - d. Other forms of *contingencies* submitted by the *System Operator*.

7.8 Reserve Requirements

- 7.8.1 The *System Operator* shall submit the level of *reserve requirement* for each type of *reserve* of each region for a period of time, while taking into account the covered period of the *market projections* and the *real-time dispatch*, and in accordance with the *timetable*.
- 7.8.2 The level of *reserve requirement* shall be based on the provisions of the *Grid Code* and the relevant *ERC* issuances on *ancillary services*.

7.9 System Status

- 7.9.1 **System Snapshot.** The *system snapshot* depicts the status of individual power facilities in the *grid*. The *system snapshot* is collected by the *Market Operator* from the *System Operator's* EMS/SCADA.

- a. The *system snapshot* contains the following information:
- *Generator Unit* MW and MVAR (analog measurements)
 - *Load* MW and MVAR (analog measurements) and
 - *Breaker Status*
 - *Bus Voltages*
 - *Frequency*
- b. The *system snapshot* is an input to the MDOM which calculates the WAP, DAP, HAP, and RTD schedules. Specifically, the *system snapshot* data is used for the network configuration and nodal demand forecasting processes.

- 7.9.2 **System Operator System Advisories.** The *System Operator system advisories* contain other information not included in the submission of *system snapshots*. Further to the information provided in Section 7.4.2, these are messages issued by the *System Operator* depicting particular events or incidents that would transpire prior, during or after real time condition.

7.10 Means of Submission/Transmittal

- 7.10.1 Data and information required to be submitted under this Section shall be transmitted by the *System Operator* through a data exchange facility provided and maintained by the *System Operator* and the *Market Operator* specifically for this purpose, based on the fields defined in Appendix E of this *Market Manual*.
- 7.10.2 The *System Operator* shall provide the information contained in this Section in accordance with the *timetable* set in Section 4.

7.11 Publication of System Operator Data

Consistent with the *Market Operator* Information Disclosure and Confidentiality Manual, the *Market Operator* shall publish in the *market information website*, for the information of *Trading Participants*, the following data as used in the *market runs*:

- a. *Outage* schedules submitted by the *System Operator* in accordance with this Dispatch Protocol; and
- b. *Over-riding constraints* submitted by the *System Operator* in accordance with this Dispatch Protocol.

SECTION 8 MARKET PROJECTIONS

8.1 Background

- 8.1.1 *WESM Rules* Clause 3.7 sets out the requirements for the preparation and publication by the *Market Operator* of the WAP, DAP, and HAP using the *market dispatch optimization model* (MDOM) and in accordance with the *WESM timetable*.
- 8.1.2 The WAP and DAP are required under the said *WESM Rules* to be prepared for all hourly intervals within the relevant *market horizon* as defined in the *WESM timetable*.
- 8.1.3 As set out in *WESM Rules* Clause 3.7.1, the WAP are to be prepared and published daily in accordance with the *WESM timetable* to assist *Trading Participants* to anticipate and respond to a range of market conditions which might reasonably be expected to occur over the forthcoming week.
- 8.1.4 The DAP, pursuant to *WESM Rules* Clause 3.7.2, are to be prepared and published regularly throughout the day in accordance with the *WESM timetable*. These projections are to assist the *Trading Participants* to anticipate and respond to a range of market conditions which might reasonably be expected to occur over the forthcoming day.
- 8.1.5 The HAP are required under the *WESM Rules* Clause 3.7.3 to be prepared for all *dispatch intervals* within the relevant *market horizon* as defined in the *WESM timetable*.
- 8.1.6 The HAP may be used as a reference by the *Market Operator* and *System Operator* to assess possible infeasible solutions that may occur and affect the succeeding execution of the RTD run. The *Market Operator* and *System Operator* shall undertake necessary actions to prevent or minimize the occurrence of infeasible solution in the forthcoming RTD runs.
- 8.1.7 The considerations and conditions that are to be taken account of in the preparation of these *market projections* are set out in *WESM Rules* Clause 3.7.4.
- 8.1.8 The *market projections* prepared by the *Market Operator* are to be published in accordance with the *WESM timetable*. The information required to be published is set out in *WESM Rules* Clause 3.7.5.

8.2 Scope and Purpose

The procedures and requirements set out in this Section shall be implemented in the preparation of the WAP, DAP, and HAP, collectively referred to in this Dispatch Protocol as the *market projections*.

8.3 Responsibilities

8.3.1 The *Market Operator* shall be responsible for the following:

- a. Ensuring that the timely preparation of the WAP, DAP, and HAP *market runs* are carried out in accordance with the *WESM timetable*;
- b. Publishing and disseminating the WAP and DAP results in accordance with the *WESM timetable* and with the procedures, requirements and conditions set out in *WESM Rules* Clause 3.7 and other relevant clauses and this Section; and
- c. Maintaining the *MMS* which is the infrastructure that is used to support the operations of the *WESM*, including, among other processes, the execution of the various market runs, the publication of market results to the *Trading Participants* and the *System Operator*, and the submission of data and other inputs from the *System Operator* and the *Trading Participants*.

8.3.2 The *System Operator* shall be responsible for:

- a. Preparing and ensuring timely submission to the *Market Operator* of the information required for the execution of the *market projection* runs as set out in the *WESM Rules* and this Dispatch Protocol; and
- b. Maintaining the necessary infrastructure it needs to carry out its functions, including, among other facilities, the data exchange facilities allowing it to transmit and receive data or information to and from the *MMS*.

8.3.3 *Trading Participants* shall be responsible for:

- a. Ensuring submission of *self-scheduled nominations, bids, and offers* as set out in the *WESM Rules* and in accordance with the *WESM timetable* and the procedures and requirements set forth in this Dispatch Protocol; and
- b. Maintaining their respective infrastructure to ensure access to the *MPI* of the *MMS*.

8.4 Data Inputs/Information Requirements

8.4.1 Pursuant to *WESM Rules* Clause 3.7.4, the *market projections* shall take into consideration various data inputs. These inputs shall be made available or submitted to the *Market Operator* in accordance with the *WESM timetable* and the procedures set out in this Dispatch Protocol and relevant provisions of the *WESM Rules*.

8.4.2 The data inputs for the *market projections* are as follows:

- a. *Generation energy and reserve offers, self-scheduled nominations, and demand bids*
- b. *Demand/load forecast* determined in accordance with the *WESM Load Forecasting Methodology*

- c. *System snapshot*
- d. *Outage schedules*
- e. *Reserve Requirements*
- f. *Contingency list*
- g. *Transmission limits*
- h. *Over-riding constraints*
- i. *System advisories*

8.4.3 Data to be submitted to and considered by the *Market Operator* shall be within the *market horizon* covered by the relevant *market projection*.

8.5 Outputs/Results of Market Projections

8.5.1 The *market projections* use the MDOM to determine the following:

- a. *Energy dispatch* targets for the end of an interval;
- b. *Reserve* schedules for the entire interval;
- c. *Energy prices* at all *market trading nodes*, and
- d. *Reserve region* prices.

8.5.2 Where *constraint violation coefficients* (CVCs) are encountered in the *market projections*, the results will already reflect prices based on the *automatic pricing re-run*.

8.6 Publication and Dissemination of Market Projection Results

8.6.1 The results of the *market projections* shall be transmitted to the *System Operator* in the format prescribed in Appendix A of this *Market Manual*.

8.6.2 If the *market run* results show the occurrence of CVCs, the *System Operator* shall be notified of these results through a market advisory which shall be transmitted in the format set out in Appendix A of this *Market Manual*.

8.6.3 If the results of *market projections* indicate that *nodal energy dispatch prices* are expected to be equal to, or exceed, *nodal VoLL* at any *customer market trading nodes* in the *market network model*, the *System Operator* shall be notified of the likelihood of initiating loss of *load* at those *nodes* through a market advisory which shall be transmitted in the format set out in Appendix A of this *Market Manual*.

8.6.4 The results of the *market projections* shall be published and notified to the *Trading Participants* through the *MPI*. *Trading Participants* shall be provided with the following information pertaining to their respective registered resource (i.e. *generating unit* or *load*):

- a. *Energy Dispatch schedule*
- b. *Nodal Energy Price*
- c. *Reserve Schedule* for specific *Reserve Type*
- d. *Regional Reserve Price* for specific *Reserve Type*

8.6.5 Other system data that will be published and be made available to all *Trading Participants* through the *MPI* shall include the following:

- a. Total *energy* dispatched
- b. Total *dispatchable load*
- c. Total system losses
- d. *Reserve* requirements

8.7 Archiving of Market Projections

The *Market Operator* shall archive the input data as well as the results of each *market projection*. The archived information shall be retrieved and utilized by the *Market Operator* for validation as well as for the conduct of sensitivity analysis and other simulation studies. Data retention shall be in accordance with *WESM Rules* Clause 9.7.

SECTION 9 REAL-TIME DISPATCH SCHEDULING

9.1 Background

- 9.1.1 *WESM Rules* Clause 3.8 sets out the responsibilities of the *Market Operator* in the scheduling of *generation* and *load* in the *WESM*. Among other responsibilities, *WESM Rules* Clause 3.8.1 directs that prior to the commencement of each *dispatch interval*, the *Market Operator* shall use the *market dispatch optimization model* (MDOM) to determine the target *loading level* in MW for each *non-scheduled generating unit*, *must dispatch generating unit*, *priority dispatch generating unit*, *scheduled generating unit* or each *scheduled load* and for each *reserve facility* for the end of the *dispatch interval* using the latest data from the *System Operator* and the *Trading Participants*. The *Market Operator* shall submit to the *System Operator* the *dispatch schedule* containing the *target loading levels* to be achieved at the end of the *dispatch interval*.
- 9.1.2 The *WESM Rules* defines *loading level* as the instantaneous level of output or consumption in MW of a *generating unit* or *load*. The *target loading level* of a *generator* or *load* is the *loading level* determined as an end-of-period target for that scheduled *generator* or *load*.
- 9.1.3 Additionally, the *Market Operator* is required under *WESM Rules* Clause 3.10 to calculate and publish the RTD prices.

9.2 Purpose and Scope

This Section describes the requirements and procedures for the generation and publication of the *real-time dispatch schedules* and prices.

9.3 Responsibilities

- 9.3.1 The *Market Operator* shall be responsible for the following:
- a. Ensuring that the RTD *market runs* are carried out in accordance with the *WESM timetable*;

- b. Publishing and disseminating the RTD results in accordance with the *WESM timetable* and with the procedures, requirements and conditions set out in *WESM Rules* Clause 3.8 and Clause 3.9 and other relevant clauses and this Dispatch Protocol;
- c. Preparing and ensuring timely submission to the *System Operator* of the *real-time dispatch schedule*, including the *WMOT*, in preparation for the *dispatch* implementation as set out in the *WESM Rules* and this Dispatch Protocol; and
- d. Maintaining the *Market Management System (MMS)* which is the infrastructure that is used to support the operations of the *WESM*, including, among other processes, the execution of the various *market runs*, the publication of market results to the *Trading Participants* and the *System Operator*, and the submission of data and other inputs from the *System Operator* and the *Trading Participants*.

9.3.2 The *System Operator* shall be responsible for:

- a. Preparing and ensuring timely submission to the *Market Operator* of the information required of it for the execution of the RTD runs as set out in the *WESM Rules* and this Dispatch Protocol; and
- b. Maintaining the necessary infrastructure it needs to carry out its functions, including, among other facilities, the data exchange facilities allowing it to transmit and receive data or information to and from the *MMS*.

9.3.3 *Trading Participants* shall be responsible for:

- a. Ensuring submission of *market offers* and *reserve offers* as set out in the *WESM Rules* and in accordance with the *WESM timetable* and the procedures and requirements set forth in this Dispatch Protocol.
- b. For *scheduled generating units* and *priority dispatch generating units* who are *dispatched*, generating in accordance with the *dispatch schedule* communicated and within *dispatch conformance the standards* set forth in this *Market Manual*.
- c. Maintaining their respective infrastructure to ensure access to the Market Participant Interface of the *MMS*.

9.4 Schedule and Coverage of Real-time Dispatch Scheduling

- 9.4.1 The execution of the *real-time dispatch* scheduling processes shall be in accordance with the *WESM timetable*.

9.5 Data Inputs/Information Requirements

The data and information set forth in Table 6 below must be available and must be submitted to the *Market Operator* prior to the execution of the *real-time dispatch schedules* in accordance with the *WESM timetable*. Submission shall be in accordance with the schedules and format

set out in Sections 6 and 7 of this Dispatch Protocol or, for the *load forecasts*, under the Load Forecasting Methodology Manual.

Table 6. Summary of Inputs and Sources for the *Real-time dispatch*

INPUTS	SOURCE
<i>Bids, Offers or Self-scheduled nomination</i>	<i>Trading Participants</i>
<i>Load forecast</i>	<i>Market Operator</i>
<i>System Snapshots</i>	<i>System Operator</i>
<i>Outage Schedule</i>	<i>System Operator</i>
<i>Reserve Requirement</i>	<i>System Operator</i>
<i>Contingency List</i>	<i>System Operator</i>
<i>Over-riding constraints</i>	<i>System Operator</i>
<i>System Advisories</i>	<i>System Operator</i>

9.6 Outputs/Results of Real-time Dispatch Scheduling

9.6.1 The MDOM simultaneously determines the following:

- a. *Target loading levels* in MW for the end of a *dispatch interval*, identified as the RTD schedule
- b. *Reserve allocations* for the *dispatch interval*;
- c. *Associated energy prices* at all *market trading nodes*, and
- d. When applicable, *reserve prices* for all *reserve regions*.

9.6.2 Where *constraint violation coefficients* (CVCs) are encountered in the *market runs*, the results will already reflect prices based on the *automatic pricing re-run*.

9.7 Dissemination and Publication of Market Run Results

9.7.1 The RTD schedule shall be transmitted to the *System Operator* in the format prescribed in Appendix D of this *Market Manual*. If the *market runs* results in occurrence of CVCs, this shall be notified to the *System Operator* through market advisories, which shall be transmitted in the format prescribed in Appendix D of this *Market Manual*.

9.7.2 The RTD results shall be published and notified to the *Trading Participants* through the Market Participant Interface (MPI). The *Trading Participants* shall be provided following information pertaining to their respective registered resource (i.e., *generating unit* or *load*):

- a. *Energy Dispatch schedule*
- b. *Nodal Energy Price*
- c. *Reserve Schedule* for specific *Reserve Type*
- d. *Regional Reserve Price* for specific *Reserve Type*

9.7.3 Other system data that will be published and be made available to all *Trading Participants* through the *market information website* shall include the following:

- a. *Total energy dispatched*
- b. *Total dispatchable load*

- c. Total system losses
- d. Reserve requirements
- e. Locational marginal prices

9.8 Archiving of RTD Market Runs

- 9.8.1 The *Market Operator* shall archive the input data as well as the results of each RTD *market run* that have been carried out. The archived information shall be retrieved and utilized by the *Market Operator* for validation as well as for the conduct of sensitivity analysis and other simulation studies. Data retention shall be in accordance with *WESM Rules* Clause 9.7.

SECTION 10 PREPARATION OF THE WESM MERIT ORDER TABLE

10.1 Background

- 10.1.1 The *WESM merit order table (WMOT)* is prepared as a guide for the *System Operator* in selecting *generating units* that can be re-dispatched in the course of the operations of the *power system*. The use of the *WMOT* by the *System Operator* shall be in accordance with the re-dispatch process described in the relevant Section of this Dispatch Protocol.
- 10.1.2 The *WMOT* is generated by stacking in an unconstrained manner of scheduled and unscheduled capacities, excluding negative quantities through the *market offers* submitted for the *real-time dispatch* runs. *Energy offer* blocks submitted by *generator Trading Participants* for a particular *dispatch interval* are arranged from lowest to the highest priced *offer* block, without considering any *constraints*. The *WMOT* stacks *energy offers* into two, namely, the *energy offers* that were scheduled (or “Offers Dispatched”) and *energy offers* that were not scheduled (or “Offers Not Dispatched”).
- 10.1.3 The *System Operator* utilizes the *WMOT* of Offers Dispatched as a guide in determining which *generating units* may be constrained-off, whereas the *WMOT* of Offers Not Dispatched is a guide for determining which *generating units* may be constrained-on for a particular *dispatch interval*.
- 10.1.4 The *Market Operator* prepares a separate *WMOT* for each of the *grids* where the *WESM* is in commercial operation.

10.2 Purpose and Scope

This Section sets out the requirements and procedures for the preparation and use of the *WMOT* in the *dispatch* of *generating units*.

10.3 Responsibilities

- 10.3.1 The *Market Operator* shall be responsible for preparing, disseminating and publishing the *WMOT* in accordance with the procedures set out in this Section.

10.3.2 Consistent with its obligations set out in this Dispatch Protocol in respect to the issuance of *dispatch instructions*, the *System Operator* shall be responsible for ensuring the application of the information provided in the *WMOT* in the real-time operation of the *grid*. The *System Operator* shall also be responsible for identifying the *generating units* designated as *must-run units* through the *dispatch* deviation report and report on *must-run units* prepared in accordance with Sections 14.4.2 and 14.4.5.

10.4 Preparation of the WMOT

10.4.1 The *WMOT* shall be prepared using the *offers*, excluding negative quantities, and the *real-time dispatch schedule* of each *generating system* for which *offers* were submitted for the relevant *dispatch interval*. The specific information that will be used is as follows:

Table 7. Inputs for the Preparation of the WMOT

Information	Description
Resource ID	Generating unit ID as registered in the <i>MMS</i>
OFFER DATA	
MW	MW Quantity relevant to <i>offer</i> block
Block	<i>Offer</i> block number
Price	<i>Offer</i> Price relevant to <i>offer</i> block
RTD SCHEDULE	
MW	<i>Dispatch</i> target for the <i>generating unit</i>

10.4.2 The *WMOT* shall include the following:

- a. All *generating units* for which *offers* have been submitted for the relevant *dispatch interval*; and
- b. All *generating units* which have been scheduled or included in the RTD schedule as a result of the imposition of *over-riding constraints*, with or without *offers* submitted for that *dispatch interval*.

10.4.3 The following *generating units* shall be excluded in the *WMOT*:

- a. *Generating units* which are on *outage* as reflected in the *outage* schedule submitted by the *System Operator*, and
- b. *Generating units* which are not available as reflected in the network configuration considered in the RTD *market run*.

10.4.4 The *energy offers* for all *generating units* with *offers* will be segregated into two, namely, the:

- a. Offers Dispatched
- b. Offers Not dispatched

10.4.5 The “Offers Dispatched” consists of the *energy offer* blocks which have been scheduled in the RTD schedule for the *dispatch interval*. To the extent possible, the *dispatch schedule* of each *generating unit* will be split into corresponding *offer* blocks. The scheduled *offer* blocks will then be sorted and listed from the lowest-priced to the

highest-priced scheduled *offer* block, with the lowest-priced scheduled *offer* block at the bottom of the list and the highest-priced at the top of the list. The *generating units* for which no *offers* are submitted but were scheduled are considered as price takers. Their respective schedules, MW, are included in this list and are placed at the bottom of the list with *must dispatch generating units* at the bottom and followed by *priority dispatch generating units* and *non-scheduled generating units* in that order.

10.4.6 The “Offers Not Dispatched” consists of the remaining *energy offers* of each *generating unit* that are not scheduled or included in the RTD schedule for the *dispatch interval*. To the extent possible, the remaining *offers* will be sorted by *offer* blocks. The *offer* blocks not dispatched will then be sorted and listed from the lowest-priced to the highest-priced scheduled *offer* block, with the lowest-priced scheduled *offer* block at the bottom of the list and the highest-priced at the top of the list. Capacities that were not dispatched through their *energy offers* but have *reserve dispatch* targets shall be excluded from the list.

10.4.7 Appendix B presents a step-by-step illustration on how the *WMOT* is prepared.

10.5 Output of the WMOT

10.5.1 The *WMOT* shall contain the following information:

Table 8. Information provided in the WMOT

Information	Description
Resource ID	<i>Generating unit</i> ID as registered in the <i>MMS</i>
MW	MW Quantity relevant to <i>offer</i> block
Block	<i>Offer</i> block number
Running Total	Incremental value based on MW Quantity <ul style="list-style-type: none"> ▪ Offers Scheduled for Dispatch – increment starts from the top of this list ▪ Offers Not Scheduled for Dispatch – increment starts from the bottom of this list

10.5.2 The *WMOT* shall be published in substantially the form as presented in Appendix C of this Dispatch Protocol.

10.6 Use of the WMOT

10.6.1 The *System Operator* shall use the *WMOT* as reference whenever there is a requirement to constrain on or constrain off the *dispatch schedule*. However, the *System Operator* may resort in an out-of merit dispatch whenever the grid frequency is beyond the normal threshold.

10.6.2 As far as practicable, and when *secondary reserves* have been exhausted, the *System Operator* shall issue re-dispatch instructions based on the *WMOT*. However, the *System Operator* may resort in an *out of merit dispatch* whenever the quality of the *grid frequency* is affected or the *security* of the *grid* is at risk.

10.7 Reporting and Publication

- 10.7.1 The *WMOT* per *dispatch interval* shall be transmitted to the *System Operator* immediately after its preparation, through the EMS-MMS data exchange facility.
- 10.7.2 The *WMOT* shall be published in the *market information website* after the expiration of confidentiality of *generator offer* information in accordance with the *Market Operator Information Disclosure and Confidentiality Manual*.

SECTION 11 DISPATCH IMPLEMENTATION

11.1 Background

- 11.1.1 The *target loading levels* shall be determined and communicated prior to the commencement of the *dispatch interval* and in accordance with the *WESM timetable*.
- 11.1.2 The *dispatch schedule* shall contain the *target loading levels* to be achieved in MW considered at the end of that *dispatch interval*. *Generators* who are dispatched shall comply in accordance with the *dispatch schedule* communicated and within *dispatch conformance standards* set forth in this *Market Manual*. Dispatched *Trading Participants* will not be required to operate in any different manner unless required to respond in accordance with reserve or ancillary services contract or respond to a direction by the *System Operator*⁵.
- 11.1.3 During each *dispatch interval*, the *Trading Participant* is directed under *WESM Rules Clause 3.8.4.1* to implement the *dispatch targets* determined by the *Market Operator*.
- 11.1.4 At any given *dispatch interval*, the *System Operator* shall issue re-dispatch *instructions* in accordance to the *WMOT* and shall make an out-of-merit *dispatch* when the *system security* is at risk.

11.2 Purpose and Scope

- 11.2.1 This Section discusses the procedures that will be followed in the implementation of the *real-time dispatch schedules* for *energy* and *reserves*. It also provides for guidelines that will be followed by the *System Operator* in issuing re-dispatch *instructions* during a *dispatch interval*.
- 11.2.2 The procedures set out in this Section are associated with the following procedures:
- a. Procedures for the *dispatch of generating units* which are scheduled to *start-up* or *shutdown* are set out in Section 13 of this Dispatch Protocol;
 - b. Designation and *dispatch of must-run units* which are set out in Section 17 of this Dispatch Protocol;

⁵ *WESM Rules Clause 3.8.4.1*

- c. Procedures during *market intervention* and *market suspension* which are set out in Section 16 of this Dispatch Protocol;
- d. Procedures during alert or *emergency* conditions which are set out in Section 20 of this Dispatch Protocol;
- e. Management of *excess generation* which is set out in Section 18 of this Dispatch Protocol; and
- f. Management of *load shedding* which is set out in Section 19 of this Dispatch Protocol.

11.3 Responsibilities

11.3.1 The *System Operator*, in coordination with the *Market Operator*, shall be responsible for the following:

- a. Monitoring the implementation of *dispatch* targets as determined by the *Market Operator* at the end of each *dispatch interval*;
- b. Implementing the *WMOT* provided by the *Market Operator*;
- c. Assuring the *security* and reliability of the *grid* at all times in compliance with the provisions of the System Security and Reliability Guidelines and *Grid Code*;
- d. Dispatching *generators* as *constrain-on* or *constrain-off*, or as *must-run unit* if all available *reserves* are exhausted during a *dispatch interval*; and
- e. Reporting events and actions made during *dispatch intervals*

11.3.2 The *Market Operator* shall be responsible for ensuring timely transmittal to the *System Operator* and publication to the *Trading Participants* of the *real-time dispatch schedules*, for *energy* and *reserves*, and the *WMOT* determined for a *dispatch interval*, in accordance with the timelines set in the *WESM timetable*.

11.3.3 All *Trading Participants* shall comply with their respective *dispatch schedules* issued by the *Market Operator* and the re-dispatch instructions issued to them by the *System Operator*, if any. For this purpose, they shall ensure that their respective internal processes, systems and infrastructure, as well as their protocols with their counterparties, shall enable strict compliance with this Section.

11.4 Issuance and Coverage of Dispatch Instructions

11.4.1 *Dispatch instructions* shall include the following:

- a. During normal condition, the *MW dispatch* of power *facilities* shall be the *dispatch schedule* for the *dispatch interval* submitted by the *Market Operator*.
- b. In cases when the conditions in real-time changes from the condition in the original run, the *System Operator* shall re-dispatch according to Section 11.6 of this *Market Manual*.

11.4.2 The *Market Operator* shall communicate the *target loading levels* to the *Trading Participants* through the *MPI*. All *dispatch* targets shall be specified in units of megawatt (MW) and will apply to the end of the relevant *dispatch interval* unless otherwise stated.

11.4.3 **System Operator Clearance.** When the *grid frequency* is not within the normal threshold, the *Trading Participants* shall seek clearance from the *System Operator* before ramping up or down to their respective *target loading levels*. The *System Operator* shall provide clearance and issue *dispatch instructions* as it deems appropriate.

11.5 Dispatch of Must and Priority Dispatch Generating Units

11.5.1 A *must dispatch generating unit* shall generate at its *maximum available output* at all times, unless the *Market Operator* or *System Operator* has instructed the *generating unit* to restrict output.

11.5.2 If, in real-time, the available *generation* from a *Must dispatch generating unit* differs from the available *generation* assumed in the *dispatch schedule* provided to the *System Operator*, the *System Operator* shall allow the *Must dispatch generating unit* to generate at its *maximum available output*, and, if all available *secondary reserves* are exhausted during a *dispatch interval*, shall adjust the *dispatch* of other *generating units* to compensate as required in accordance with re-dispatch process in this Section.

11.5.3 The *System Operator* shall instruct a *Must dispatch generating unit* or a *priority dispatch generating unit* to restrict its output or constrain its *ramp rate* to a level specified by the *System Operator*, but only while the *grid* is not operating in *normal state*. If the *System Operator* has instructed a *Must dispatch generating unit* or a *priority dispatch generating unit* to restrict its output, the *System Operator* shall instruct the *generating unit* to remove the restriction as soon as practicable after the actual or potential *system security* issue has been resolved.

11.6 Conditions for Re-Dispatch

11.6.1 Re-dispatch shall be carried out under the conditions set out in this Section. Re-dispatch instructions shall be issued by the *System Operator*.

11.6.2 In cases of the occurrence of system *emergencies*, a threat to *system security*, or an event of *force majeure*, of the nature described in Chapter 6 of the *WESM Rules* and in Section 16 of this Dispatch Protocol, the *System Operator* shall declare *market intervention* in accordance with said Chapter 6 of the *WESM Rules* and this Dispatch Protocol. While *market intervention* is in effect, the *System Operator* shall take control of the *dispatch* of *generating units* in accordance with the procedures set out specifically for *market intervention*. The *System Operator* shall notify the *Market Operator* of its actions.

11.6.3 Where the results of the *ex-ante* or *real-time dispatch market runs* reflect *constraint violation coefficients* (CVCs), the *System Operator* shall use all reasonable endeavors to *dispatch generating units* in accordance with the RTD schedules and the *WMOT* generated and communicated by the *Market Operator* for the relevant *dispatch interval*. The *System Operator* shall, however, issue the necessary re-dispatch instructions to address the condition that gave rise to the occurrence of the CVCs.

11.6.4 In cases when normal market conditions prevail but there is an imbalance in supply and *demand* within the *dispatch interval* and all available *reserves* have been

exhausted, the *System Operator* may issue *re-dispatch instructions*. The *System Operator* shall *constrain-on* or *constrain-off* generators using the *WMOT*.

11.6.5 In an event where all available *reserves* have been exhausted to address a threat in *system security* covered under Section 11.6.2, the *System Operator* may designate *generating units* to operate on *must-run unit* and they shall be re-dispatched out-of-merit to ensure the reliability and *security* of the *grid* in accordance with the selection criteria provided in Section 17.2.

11.7 Re-dispatch Procedures

11.7.1 The *System Operator* shall re-dispatch *generating units* using the *WMOT* in accordance with the following procedure:

- a. Instruct *generators* to ramp-up (or ramp-down) following the *WMOT*.
- b. Report to the *Market Operator* the list of *generating units* instructed to ramp-up and would be designated as *must-run units*.

11.7.2 The *System Operator* shall designate *generating units* to operate as *must-run units* and shall issue re-dispatch instructions in accordance with Section 17.3 of this Dispatch Protocol.

11.7.3 The *System Operator* shall inform the *generating unit* that it shall be re-dispatched as either a *constrain-on generator*, *constrain-off generator*, or a *must-run unit* for the relevant *dispatch interval*. The re-dispatched target MW loading shall also be communicated to the *generating unit/plant*.

11.7.4 *Generators* whose generating plants received re-dispatch instruction shall immediately and strictly comply with the corresponding *dispatch instructions* of the *System Operator*.

11.7.5 After complying with the re-dispatch instructions, *generators* shall immediately follow the *dispatch schedules* for the next *dispatch interval*.

11.8 Communicating and Reporting of Dispatch Schedules and Instructions

11.8.1 The *real-time dispatch* targets shall be communicated by the *Market Operator* to the *Trading Participants* through the *MPI*. The *WMOT* generated for a *dispatch interval* shall be published in accordance with Section 10.7.2 of this Dispatch Protocol. Re-dispatch instructions shall be communicated by the *System Operator* to the *Trading Participants* through their respective power plant operators.

11.8.2 The *System Operator* shall maintain the communication facilities it needs for communicating with *Trading Participants* which may include telephones, fax, email, web pages and other means of communications.

11.8.3 All exchanges of information or communications between the *System Operator*, *Market Operator*, and *Trading Participants* shall be recorded by the parties concerned and shall be made available for audit, surveillance, investigations and enforcement actions.

As appropriate, records may include, but shall not be limited to, operator logs, voice recording, electronic communications and written communications.

- 11.8.4 All *dispatch instructions* issued by the *System Operator* to *Trading Participants* shall be recorded through operator logs. The *System Operator* shall include this information in the dispatch deviation report, in accordance with Section 14.4.
- 11.8.5 Dispatch deviation reports submitted by the *System Operator* to the *Market Operator* shall be used for purposes of surveillance, audit, and market settlements.
- 11.8.6 The *Market Operator*, in coordination with the *System Operator*, shall prepare, disseminate and publish the reports referred to in the foregoing sections as well as other *dispatch* reports and information in accordance with requirements and procedures set out in this Section and other relevant Sections of this Dispatch Protocol and other relevant *Market Manuals*.

SECTION 12 DISPATCH COMPLIANCE

12.1 Background

- 12.1.1 A *Generation Company* is required to operate their *scheduled generating units* and/or *priority dispatch generating units* in accordance with the scheduling and *dispatch* procedures described in Chapter 3 of the *WESM Rules*.⁶ More specifically, *scheduled generating units* and *priority dispatch generating units* shall generate in accordance with the *dispatch schedules* communicated pursuant to *WESM Rules* Clause 3.8.1⁷ and in accordance with the *dispatch conformance standards* specified in Clause 3.8.5.⁸ They are to follow such schedules unless otherwise restricted or instructed by the *System Operator*.⁹
- 12.1.2 The *Market Operator* is required to develop and publish the *dispatch conformance standards*, in consultation with the *System Operator* and *Trading Participants*. Such standards shall be in accordance with *WESM Rules* Clause 3.8.5, and be consistent with the *Grid Code*, and the *Distribution Code*.¹⁰
- 12.1.3 A *must dispatch generating unit* shall generate at its *maximum available output* at all times, unless the *Market Operator* or *System Operator* has instructed the *generating unit* to restrict its output.¹¹ If the scheduled output has been so restricted pursuant to *WESM Rules* Clauses 3.6.1.7 and 3.6.1.8, the *Must dispatch generating unit* shall ensure its output does not exceed the value included in the *dispatch schedule*.¹² The

⁶ WESM Rules Clause 2.3.1.8

⁷ WESM Rules Clause 3.8.1 (g)

⁸ WESM Rules Clause 3.8.4.1

⁹ WESM Rules Clause 3.8.3.2, Clause 3.8.4.1 (a) and (b), Clause 3.8.4.2, and Clause 3.8.3.

¹⁰ WESM Rules Clause 3.8.5.1

¹¹ WESM Rules Clause 3.8.4.4

¹² WESM Rules Clause 3.8.4.3

System Operator may also instruct a *Must dispatch generating unit* to restrict its output or constrain its *ramp rate* when the *grid* is not in a normal state.¹³

12.1.4 A *Trading Participant* that does not comply with the *dispatch conformance standards* or that fails to exercise reasonable endeavors to comply with the instructions issued by the *System Operator* may be liable of sanctions imposed under *WESM Rules* Clause 7.2.¹⁴

12.2 Scope and Purpose

12.2.1 This Section describes the *dispatch* compliance obligations of *Trading Participants* in the *WESM*, particularly in respect to compliance with *energy dispatch schedules* of *scheduled generating units*, *non-scheduled generating units*, *priority dispatch generating units* and *Must dispatch generating units*.

12.2.2 For *scheduled generating units* and *priority dispatch generating units*, this Section establishes the *dispatch conformance standards* and procedures for monitoring compliance that are required to be established and be set out in a *Market Manual* pursuant to *WESM Rules* Clause 3.8.5.

12.2.3 This Section shall apply to all *Trading Participants* that are registered as *Generation Companies* in the *WESM*.

12.2.4 This Section covers only the obligations in respect to compliance with *energy dispatch schedules*. It does not cover standards for compliance by *Ancillary services providers* with their *ancillary service* or *reserve* schedules which shall be in accordance with the relevant provisions of the *WESM Rules* and other applicable *Market Manual* or relevant sections of this Dispatch Protocol.

12.3 Responsibilities

12.3.1 The *System Operator* is responsible for coordinating with the *Market Operator* for the periodic review of the *dispatch conformance standards* as well as of the procedures set out in this Section.

12.3.2 The *Market Operator* is responsible for:

- a. Coordinating with the *System Operator* for the periodic review of the *dispatch conformance standards* as well as of the procedures set out in this Section; and
- b. Providing a mechanism for monitoring and for notifying *Trading Participants* of possible breach by *scheduled generating units* and *priority dispatch generating units* with the *dispatch conformance standards*.

12.3.3 *Trading Participants* shall comply with their *dispatch* compliance obligations as set out in the *WESM Rules* and as detailed further in this Dispatch Protocol and submit the non-conformance report required under this Section.

¹³ *WESM Rules* Clause 3.8.3.5

¹⁴ *WESM Rules* Clause 3.8.6

12.4 Compliance with Dispatch Schedules and Instructions

12.4.1 Compliance by the *Scheduled Generating Units* and *Priority Dispatch Generating Units*.

- a. All *scheduled generating units* and *priority dispatch generating units* shall comply with their respective *dispatch schedules*. In complying with their *dispatch schedules*, said *generating units* shall generate in accordance with *dispatch conformance standards*¹⁵ prescribed in Section 12.5 of this Dispatch Protocol. In the case of a *priority dispatch generating unit*, compliance with the *dispatch conformance standards* shall also apply in cases where its *dispatch schedule* was restricted pursuant to *WESM Rules* Clauses 3.6.1.7 and 3.6.1.8 because of a potential *system security contingency*.
- b. If re-dispatch instructions or *emergency* directions were issued by the *System Operator* to a *scheduled generating unit* or *priority dispatch generating unit* under the circumstances described in Section 11 of this Dispatch Protocol, the *generating unit* re-dispatched or directed shall comply with the *dispatch instructions* of the *System Operator* in accordance with Section 12.4.4 of this Dispatch Protocol.
- c. If a *priority dispatch generating unit* was instructed by the *System Operator* to restrict its output or constrain its *ramp rate* when the *grid* is not in a normal state¹⁶, the *generating unit* so instructed shall comply with such instructions in accordance with Section 12.4.4 of this Dispatch Protocol.
- d. A *Trading Participant* that expects its registered facility to operate in a manner that, for any reason, differs materially from the *System Operator's dispatch instructions* shall so notify the *System Operator* as soon as possible.

12.4.2 Compliance by the *Must Dispatch Generating units*

- a. A *must dispatch generating unit* shall generate at its *maximum available output* at all times, unless it has been instructed to restrict its output by the *Market Operator* or *System Operator*.
- b. If the scheduled output of a *must dispatch generating unit* has been restricted pursuant to *WESM Rules* Clauses 3.6.1.7 and 3.6.1.8, the *Trading Participant* shall ensure its output of that *generating unit* does not exceed the value stated in the *dispatch schedule*.
- c. If the *must dispatch generating unit* was instructed by the *System Operator* to restrict its output or constrain its ramp rate, it shall comply with such instructions in accordance with Section 12.4.4 of this Dispatch Protocol.

¹⁵ WESM Rules, Glossary

¹⁶ WESM Rules Clause 3.8.3.5

12.4.3 Compliance by the *Non-scheduled Generating Units*

- a. A *non-scheduled generating unit* shall generate in accordance with their *dispatch schedules*.
- b. If the *non-scheduled generating unit* was re-dispatched by the *System Operator* or was otherwise directed to generate differently from its *dispatch schedules*, it shall comply with such instructions in accordance with Section 12.4.4 of this Dispatch Protocol.

12.4.4 Compliance with *System Operator* Instructions

- a. All *generating units* that were re-dispatched or were otherwise given *dispatch instructions* by the *System Operator* that differ from their respective *dispatch schedules* shall use reasonable endeavors to comply with said re-dispatch instructions.
- b. The foregoing shall not apply in cases where the instructions were issued to an *Ancillary Service Provider* for the provision of *ancillary services* or otherwise to comply with *ancillary services* schedules. In such cases, the standards for compliance shall be as set out in relevant provisions of the *WESM Rules*, this Dispatch Protocol or other *Market Manuals*.

12.5 Dispatch Conformance Standards

12.5.1 Dispatch Compliance Criteria

- a. Compliance by a *generating unit* with its *dispatch schedule* is determined based on the extent of the dispatch deviation incurred by the dispatched *generating unit* in relation to the dispatch threshold and is measured over a prescribed period or number of intervals.
- b. All *scheduled* and *priority dispatch generating units* shall not deviate beyond the upper and lower dispatch thresholds of +1.5% or -3% of the *dispatch schedule* or +/-1MW, whichever is higher, as follows:

$$\text{Upper Dispatch Threshold} = \text{RTD} + \text{Max}[1, (1.5\% \times \text{RTD})]$$

$$\text{Lower Dispatch Threshold} = \text{RTD} - \text{Max}[1, (3\% \times \text{RTD})]$$

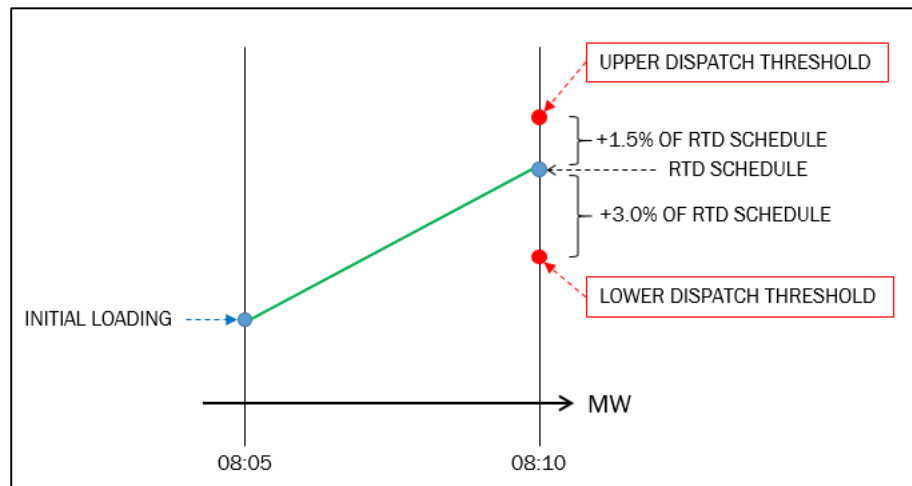

Figure 7. Sample Illustration of Determining Dispatch Deviation in relation to the Upper and Lower Dispatch Thresholds

- c. **Reaction Period.** If a *generating unit* incurs a dispatch deviation beyond either the upper and lower dispatch thresholds at any *dispatch interval*, the *Trading Participant* shall take action and implement measures in order for that *generating unit* to *dispatch* within the upper and lower dispatch thresholds over four (4) *dispatch intervals*.
- d. If the *generating unit* is able to comply only on the *dispatch interval* immediately after the reaction period, it must additionally sustain compliance for no less than three (3) consecutive *dispatch intervals*.

12.5.2 Detection of Non-Compliance and Possible Breach

- a. *Scheduled generating units* and *priority dispatch generating units* shall be flagged for non-compliance with *dispatch schedules* and for possible breach of the *dispatch conformance standards*.
- b. **Non-Compliance with Dispatch Schedules.** If the *dispatch* deviation incurred by a *generating unit* is beyond the upper and lower dispatch thresholds for a particular *dispatch interval*, that *generating unit* shall be flagged as non-compliant with its *dispatch schedule* for said *dispatch interval*.
- c. The *dispatch intervals* that a *Trading Participant* is flagged as non-compliant shall be counted. The non-compliance count increments as deviations beyond the upper and lower dispatch thresholds progress through the succeeding intervals.
- d. If the unit becomes compliant within the reaction period, the non-compliance count will be stopped or reset to zero.
- e. If the unit becomes compliant after the reaction period, counting of non-compliance shall be stalled and the non-compliance count shall thus not be

incremented. Counting of non-compliance will continue and the non-compliance count will again be incremented when the generating unit is flagged as non-compliant in the succeeding interval. In this case, the non-compliance count shall only be stopped and be reset to zero if the generating unit is able to sustain *dispatch* compliance or is not flagged as non-compliant pursuant to Section 12.5.2 (b) for at least three (3) consecutive *dispatch intervals*.

- f. **Possible Breach.** The *generating unit* shall be flagged for possible breach of the *dispatch conformance standards* if the non-compliance count for a *generating unit* exceeds four (4) intervals for deviations beyond the error threshold. In such cases, further assessment shall be carried out for the purpose of establishing, among other circumstances, whether or not the non-compliance is attributed to the following:¹⁷
- i. Compliance by the *Trading Participant* with re-dispatch instructions of the *System Operator*, including but not limited to those issued pursuant to Section 11 of this Dispatch Protocol;
 - ii. For *Ancillary Services Providers*, compliance with the *System Operator* instructions pertaining to provision of *ancillary services*; or
 - iii. Compliance by the *Trading Participant* with *emergency* directions of the *System Operator* under Clause 6.3 and Clause 6.5 of the *WESM Rules*.
- g. However, if there is an impending excess generation as determined under Section 18.3 of this Dispatch Protocol, no reaction period will be applied and the *Trading Participant* shall comply with the dispatch schedules within the allowed dispatch threshold. In such cases, the counting of probable breach will start on the first non-compliance.
- h. The counting of the non-compliance and possible breach in accordance with the preceding clauses is illustrated in Appendix F of this Dispatch Protocol.
- i. The *Market Operator* shall provide a mechanism to automatically monitor *dispatch* deviation by dispatched *generating units* and to flag non-compliances in accordance with the procedure set out in the preceding paragraphs.

12.6 Reporting

12.6.1 In accordance with Section 14.4, the Post-dispatch reports required of the *System Operator* shall include the re-dispatch instructions issued to *Trading Participants*, including but not limited to instructions for provision of *ancillary services* and *emergency* directions.

12.6.2 *Trading Participants* shall submit to the *Market Operator* a daily non-conformance report that shall state, among other things, the reasons for non-compliance by their *generating units* for all instances when it is flagged for possible breach. The daily report shall cover flagged possible breach occurring within a *trading day* and shall be

¹⁷ WESM Rules Clause 3.8.5.2 (c)

submitted within three (3) *working days* or within such other periods as may be notified to the *Trading Participants* from time to time. The reports so submitted shall be made available for market surveillance, compliance monitoring and enforcement, and market audit purposes.

12.7 Review of the Conformance Standards

The *Market Operator*, in consultation with the *System Operator* and the *Trading Participants*, shall review the application and the appropriateness of the *dispatch conformance standards* semi-annually, or as may be necessary.

SECTION 13 START-UP AND SHUTDOWN OF GENERATING UNITS

13.1 Scope and Purpose

This Section sets out the principles and procedures for the *start-up* and *shutdown* of *generating units* included in the scheduling and *dispatch* processes in the *WESM*. These are set out in order to minimize disruption in the scheduling and *dispatch* processes in the *WESM* that may be caused by the *start-up* or *shutdown* of *generating units*.

13.2 Responsibilities

13.2.1 The *Market Operator* shall carry out its responsibilities in accordance with the procedures and principles set out in this Section.

13.2.2 Consistent with its obligations pertaining to *real-time dispatch* scheduling and implementation, the *System Operator* shall ensure:

- a. Continuous and timely submission and updating of the *outage* schedules, *overriding constraint* limits of *generating units* to the *Market Operator*;
- b. Issue clearance to *Trading Participants* to carry out the *start-up* or *shutdown* of their *generating units*; and
- c. Carry out the procedures set out in this Section.

13.2.3 The *Trading Participants* shall ensure their compliance with the procedures set out in this Section, and, among other responsibilities, shall ensure:

- a. Timely submission of the notices and information required of them every time they intend to *start-up* or shut down their *generating units*;
- b. Timely submission or cancellation of their *energy* and operating *reserve offers* consistent with the *WESM timetable* that is consistent with their scheduled *start-up* or shut-down;
- c. Strict compliance with their *outage* and *dispatch schedules*; and
- d. Clearance from the *System Operator* prior to the *start-up* or *shutdown* of their *generating unit*.

13.3 General Procedures

- 13.3.1 A *Trading Participant* shall request for clearance from the *System Operator* to *start-up/shutdown* its *generating unit* before the *dispatch interval* in which the *start-up/shutdown* is scheduled.
- 13.3.2 For planned *outages*, a *Trading Participant* shall request for clearance from the *System Operator* and submit the *shutdown* profile of the *generating unit* to the *System Operator* not later than seven (7) *trading days* before the *dispatch interval* in which the *shutdown* is scheduled.
- 13.3.3 The *System Operator* shall evaluate the request under Section 13.3.2 and act on the same taking into consideration the *WESM Security and Reliability Guidelines*. If the *System Operator* disapproves the request and changes the date or time of implementation, it shall notify the *Trading Participant* citing the reasons for the disapproval. The notice of disapproval shall be made no later than five (5) days prior to the original date requested by the *Trading Participant*. The *System Operator* shall also validate the *shutdown* profile submitted and notify the *Trading Participant* of any adjustments or modification that needs to be made.
- 13.3.4 The *dispatch* scheduling of the *generating unit* that will *start-up* or *shutdown* shall be managed through its *market offers* submitted within the *WESM timetable*. The *Trading Participant* shall submit *offers* for the *dispatch interval* during which the unit is to *start-up* or *shutdown* and make adjustments to its *offers*, as appropriate.

13.4 Start-up of a Generating Unit

- 13.4.1 Off-line units will not be included in the *dispatch* scheduling process. Thus, the *generating unit* must then be synchronized to the *grid* prior to the execution of the *real-time dispatch* run consistent with the *WESM timetable*.
- 13.4.2 The *System Operator* shall update the *outage* schedule of *generators* to remove the *generating unit* cleared to *start-up* from the *outage* list. Submission shall be in accordance with the *WESM timetable*. If the *start-up* will be deferred, the *System Operator* shall update the *outage* schedule accordingly and in accordance with the *WESM timetable* for submission of *outage* schedules.
- 13.4.3 Once synchronized to the *grid* and scheduled for *dispatch*, the *generating unit* shall ramp-up linearly to its adjusted operating limit that was based on its *start-up* profile in the next *dispatch interval*.
- 13.4.4 The *Trading Participant* shall update its hourly *offers* for the *dispatch intervals* covered in the *start-up* sequence.

13.5 Shutdown of a Generating Unit

- 13.5.1 *Generating units* cleared and scheduled for *shutdown* shall be included in the approved *outage* schedule submitted by the *System Operator* to the *Market Operator*.

- 13.5.2 The *generating unit* shall ramp-down linearly while shutting down until it is finally disconnected from the *grid*.
- 13.5.3 The *Trading Participant* shall update its *offers* for the *dispatch intervals* covered in the *shutdown* sequence.
- 13.5.4 Once the generating unit has completely shut down, the relevant *Trading Participant* shall cancel its daily *offer* profile for the affected *trading day*.

SECTION 14 POST DISPATCH DATA AND OPERATION REPORTS

14.1 Background

After each *dispatch interval*, the *System Operator* is required under *WESM Rules* Clause 3.8.2 to advise the *Market Operator* of the occurrence of, among other information, *dispatch* deviations, *load shedding*, *network constraints*, binding *security constraints* and operational irregularities.

14.2 Purpose and Scope

- 14.2.1 This Section sets out the requirements in respect to the Post-dispatch report required of the *System Operator*. The requirements and procedures set out in this Section apply in the *grids* where the *WESM* is in operation. The requirements set out in this Section shall be in addition to the reporting requirements and procedures set out in other Sections of this Dispatch Protocol and relevant *Market Manuals*.
- 14.2.2 The requirements and procedures in respect to the preparation, publication and dissemination of Post-dispatch reports and information required of the *Market Operator* are set out in the *Market Operator* Information Disclosure and Confidentiality Manual and in other Sections of this Dispatch Protocol.

14.3 Responsibilities

- 14.3.1 The *System Operator* shall be responsible for the preparation, updating and submission of Post-dispatch reports and information required of it under this Section and this Dispatch Protocol.
- 14.3.2 The *Market Operator* shall use and make available all reports submitted to it by the *System Operator* for settlements, audit, surveillance and enforcement purposes.

14.4 Post-dispatch Reports and Information

- 14.4.1 **Daily Operations Report.** The *System Operator* shall prepare a daily report containing the summary of its operations during each *trading day*. The *System Operator* shall submit to the *Market Operator* the Daily Operations Report not later than 1200H of the following *trading day*. The report shall include the following information:

- a. Total System *Generation*
- b. Total System *Load*
- c. Total System *Reserve*
- d. Actual Unit *Generation*
- e. *Transmission Line and Generator Outages*

14.4.2 **Dispatch Deviation Report.** For each *trading day*, the *System Operator* shall submit a report to the *Market Operator*, on a weekly basis, containing deviation to actual *dispatch* from the RTD schedule. The Dispatch Deviation Report shall contain, among others, the following information:

- a. Covered period (start time and end time)
- b. Resource name
- c. Reason for Deviation:
 - Utilized for *ancillary services*
 - Testing Requirement
 - Re-dispatch of *constrain-on* and *constrain-off generating units*
 - Designation of *must-run units*
- d. Short description of the issue being addressed (e.g. *frequency* breached x Hz)

14.4.3 **Market intervention Report.** Pursuant to *WESM Rules* Clause 6.6.2.2, the *System Operator* (for grid-related) and *Market Operator* (for market-related) shall submit a *market intervention* report, as soon as practicable, to the *Market Surveillance Committee, Market Operator, DOE* and *ERC*, after the resumption of the *spot market*. Said report shall include the details of the activities done during the duration of the *market intervention* that include as follows:

- a. the reason for the declaration of *market intervention*;
- b. the number of *dispatch intervals* affected by the *intervention*;
- c. the actions done to address the threat in *system security*; and
- d. the actual *dispatch* of all *generating units* per interval affected.

14.4.4 All reports required to be prepared and submitted under this Section shall be made available by the *System Operator* and the *Market Operator* for purposes of settlements, audit, surveillance and enforcement purposes.

14.4.5 **Report on Must-run Units.** In accordance with *WESM Rules* Clause 3.5.13.1, the *System Operator* shall submit a report to the *Market Operator* identifying all the *generating units* designated as *must-run units* within the *trading day*, as well as information necessary for the proper settlement of such *generating units*.

14.4.6 Reports prepared pursuant to Sections 14.4.1 and 14.4.2 shall be published in the *market information website* in accordance with the *Market Operator* Information Disclosure and Confidentiality Manual. Reports prepared pursuant to Section 14.4.5 shall be published by the *Market Operator* in the *market information website* no later than one (1) week from the relevant *trading day* in accordance with *WESM Rules* Clause 3.15.13.1. Reports on *market intervention*, in accordance with Section 14.4.3, may be provided to the *Trading Participants* upon request in accordance with *WESM Rules* Clause 6.9.4.2.

SECTION 15 SCHEDULING AND DISPATCH OF RESERVES

15.1 Background

Upon the commencement of the trading of *reserves* in the *WESM*, the scheduling and *dispatch* of *reserves* that are traded in the *WESM* shall be in accordance with the requirements and procedures set out in the *WESM Rules*.

15.2 Scope and Purpose

The criteria and procedures set out in this Section cover only the requirements for the types of *reserves* that are to be traded in the *WESM*. Procedures for procurement, monitoring and settlement of other types of *ancillary services* are not within the scope of this Section or this Dispatch Protocol.

15.3 Responsibilities

15.3.1 The *System Operator* is responsible for monitoring the compliance of each *reserve* provider in the *WESM*. This compliance monitoring report shall be submitted to the *Market Operator*.

15.3.2 The *Market Operator* is responsible for ensuring that the required *reserve* levels per *System Operator* are used as inputs in pre-dispatch *market projections* and *real-time dispatch* scheduling processes in the *WESM*. It is also responsible for providing and maintaining the facility for timely receipt of submissions from the *System Operator*.

15.4 Determination of Reserve Requirements

15.4.1 **Criteria for Determining Reserve Requirements.** In determining *reserve* requirements for each *reserve* type in accordance with the relevant *ERC* issuances on the procurement of *ancillary services*, the *System Operator* shall ensure compliance with the power quality and reliability performance standards set out in the *Philippine Grid Code*.

15.4.2 The level of *reserve* requirement for secondary *reserve* service shall be based on the latest issuances on the procurement of *ancillary services* by the *ERC*, and shall be used as reference by the *Market Operator* for the *market projections* and *real-time dispatch schedule*.

15.4.3 For *primary reserve* service and *tertiary reserve*, the *System Operator* shall determine the level of *reserve* requirement in accordance with the latest issuances on the procurement of *ancillary services* by the *ERC*.

15.4.4 The *Market Operator*, in coordination with the *System Operator*, shall formulate and maintain its procedures for determining the MW level of the *reserve* requirements.

15.5 Submission of Reserve Requirements

15.5.1 **Reserve Levels.** The *Market Operator* shall submit the relevant results of the *week-ahead* and *day-ahead projections* to the *System Operator* for the determination of the hourly *reserve* requirements.

15.5.2 **Schedule of submission.** The *reserve* requirements for a *dispatch interval* or *trading day* shall be transmitted in accordance with the *WESM Timetable* set out in this Dispatch Protocol.

SECTION 16 PROCEDURES DURING MARKET INTERVENTION OR SUSPENSION

16.1 Background

16.1.1 When the *grid* is in *Alert* or *Emergency* state as established in the *Grid Code* arising from an *emergency*, a threat to *system security* or an event of force majeure, intervention is warranted pursuant to *WESM Rules* Clause 6.2.1.2. Intervention refers to the measure taken by the *System Operator* when the *grid* is in such *Alert* or *Emergency* state condition. The specific types of events or situations that can result in the *grid* being in an *alert* or *emergency* state condition are described in Chapter 6 of the *WESM Rules*.

16.1.2 The *ERC* may also suspend the operation of the *WESM* or declare temporary market failure under the conditions set out in Section 30 of the *EPIRA*, which conditions are in cases of natural calamities or following official declaration of national or international *security emergency* by the President of the Philippines.

16.1.3 *WESM Rules* Chapter 6 sets out the measures that the *System Operator* is expected to carry out during these events and the corresponding obligations of the *Market Operator* and the *Trading Participants*. These obligations and procedures are set out in more detail in this Section.

16.2 Purpose and Scope

16.2.1 This Section establishes the guidelines and procedures that will be implemented in the *WESM* for declaring *market intervention* and for the actions that will be carried out during *market intervention*. It also describes the procedures to be implemented when the *ERC* suspends the market or declares market failure. Specifically, this Section implements relevant provisions in Chapter 6 of the *WESM Rules*.

16.2.2 This Section describes the corresponding obligations of the *Market Operator*, the *System Operator* and the *Trading Participants* during *market intervention* and *market suspension*. The reports required of the *Market Operator*, the *System Operator* and the *Market Surveillance Committee* under Chapter 6 of the *WESM Rules* are also set out in detail in this Section.

16.3 Responsibilities

16.3.1 The *Market Operator* is responsible for the following functions and shall carry them out in accordance with the *WESM Rules* and the procedures set out in this Dispatch Protocol:

- a. Notifying the *System Operator* of the occurrence of a *force majeure event* that originates in the operations of the market.
- b. Notifying the *DOE* and the *ERC* of the occurrence of an event or situation that gives rise to *market intervention* and the declaration of *market intervention* by the *System Operator*.
- c. Notifying the *System Operator* and the *Trading Participants* of the declaration of *market suspension* by the *ERC*.
- d. Notifying the *Trading Participants* of the declaration of *market intervention* by the *System Operator*.
- e. Notifying the *System Operator* and the *Trading Participants* of the following
 - Nature of the *market intervention* or *market suspension*
 - The *grid* or its specific portions that are affected by the *market intervention* or *market suspension*
 - The expected duration of the *market intervention* or *market suspension*, if known.
- f. Restoring market operations as quickly as practicable, with due consideration to the safety of persons or facilities.
- g. Issuing a market resumption notice to the *System Operator* and all *Trading Participants* indicating clearly the time and *dispatch interval* at which normal market operations is to resume.
- h. Implementing the *ERC*-approved settlement of *spot market* transactions in the *dispatch intervals* under *market intervention* or *market suspension*.
- i. Preparing a report detailing the situation that gave rise to *market intervention*, the steps taken to ensure reliable operations and remedy the causes of the *market intervention* and any recommendations for avoiding a similar occurrence in the future.

16.3.2 The *System Operator* is responsible for the following functions and shall carry them out in accordance with the *WESM Rules* and the procedures set out in this Dispatch Protocol:

- a. Notifying the *DOE*, the *ERC* and the *Market Operator* of the occurrence of an event or situation that gives rise to *market intervention* and the declaration of *market intervention*.
- b. Restoring and maintaining reliable operation of the *power system* as quickly as practicable, with due consideration to the safety of persons and facilities.
- c. Scheduling of available *generation* and *load* in the *dispatch intervals* when the *market intervention* or *market suspension* is in effect until market resumption.
- d. Provide full account of *dispatch* implementation to the *Market Operator* during *market intervention* or *market suspension*.
- e. Preparing a report detailing the situation that gave rise to *market intervention*, the steps taken to ensure reliable operations and remedy the causes of the intervention and any recommendations for avoiding a similar occurrence in the future.

16.3.3 The *Market Surveillance Committee* will perform an assessment and submit a report to the *PEM Board*, the *DOE* and the *ERC* containing the following:

- a. Adequacy of the provisions of the *WESM Rules* relevant to the event/s which occurred;
- b. Appropriateness of actions taken by the *System Operator* in relation to the event/s that occurred; and
- c. Costs incurred by the *WESM Members* as a result to responding to the event/s.

16.4 Grounds for Market Intervention and Suspension

16.4.1 **Grounds for Market Suspension.** Pursuant to Section 30 of the EPIRA and implemented in *WESM Rules* Clause 6.9.1, the *ERC* may suspend the operation of the *WESM* or declare temporary market failure in cases of:

- a. Natural calamities; or
- b. Following official declaration of national and international *security emergency* by the President of the Philippines.

16.4.2 **Grounds for Market Intervention.** *Market intervention* by the *System Operator* is permitted in *WESM Rules* Clause 6.2.1.2 when the *grid* is in Alert or *Emergency* state arising from (a) an *emergency*; or (b) a threat to *system security*, or (c) an event of force majeure. *Market intervention* is also warranted if there is an interruption in the workflows of the *Market Management System* occurring during the simulation by the *Market Operator* of its Business Continuity Plan.

16.4.3 *Emergency* is defined in *WESM Rules* Clause 6.3.1.1 as the existence of a situation which has an adverse material effect on electricity supply or which poses a significant threat to *system security*. As listed in *WESM Rules* Clause 6.3.1.2, an *emergency* may include the following:

- a. A significant supply capacity shortfall, being a condition where there is insufficient *generation* or supply options available to securely supply in one or more regions of the *power system* likely to be affected by the event;
- b. A *power system* disturbance due to an *outage* in the *transmission network* or generating system, which poses a significant threat to *system security*, for which market processes are inadequate for recovery;
- c. A significant environmental phenomenon, including weather, earthquake, floods, volcanic eruptions, tsunamis, storms or fires which are likely to or are significantly affecting the *power systems* operation for which market processes are also inadequate for recovery;
- d. A system blackout or significant *power system* under-voltage condition;
- e. Material damage to a *distribution system* which has or is likely to adversely affect the operation of the *transmission system* or to render the *spot market* ineffective; and
- f. A situation in which the Government proclaims or declares an *emergency*.

16.4.4 *Force majeure event* is defined in *WESM Rules* Clause 6.7.1 as the occurrence in the *grid* where a *dispatch interval* of an event or events not within the reasonable control, directly or indirectly, of the *Market Operator* and *WESM Member*, to the extent that

such event, despite the exercise of reasonable diligence, cannot be or be caused to be prevented, or removed and has resulted in a reduction in the normal capacity of part or all of the power *transmission system* during that *dispatch interval* and such reduction is likely to materially affect the operation of the *spot market* or materially threaten *system security*. Under *WESM Rules* Clause 6.7.2, events of force majeure shall include:

- a. Major system disturbance that caused partial or system-wide blackout;
- b. Market system hardware or software failure including that of the *System Operator* that makes it impossible to receive real-time status input data or process *market offer/bid* information to produce market schedules for *real-time dispatch* in accordance with the *WESM Rules*; and
- c. Any other event, circumstance or occurrence in nature of, or similar in effect to any of the foregoing.

16.5 Declaration of Market Suspension or Market Intervention

16.5.1 Declaration of Market Suspension. Pursuant to Section 30 of the EPIRA and its implementing rules and regulations, and *WESM Rules* Clause 6.9.1, only the ERC may declare suspension of the market or temporary market failure. It shall make such declaration in accordance with its own procedures.

16.5.2 Declaration of Market Intervention. *Market intervention* is declared by the *System Operator*, regardless of the source of the event that gave rise to such *market intervention*.

- a. Where the event that may result to intervention originates from market operations or is due to market failure, the *Market Operator* shall assess the situation and immediately advise the *System Operator* of the need to intervene in the *WESM*.
- b. Where the event that may result to *market intervention* originates from the operation of the *System Operator* or pertains to the *grid*, the *System Operator* shall assess the situation and immediately advise the *Market Operator* of the need for *market intervention*.
- c. The *Market Operator* or the *System Operator* shall notify the *ERC* and the *DOE* that an *emergency* or *force majeure event* has occurred that may lead to *market intervention*, and if possible, the notice shall indicate the expected duration of the same. The responsibility for giving such notice shall depend on the source or origin of the event.

16.5.3 Regional Declaration of Market Intervention and Market Suspension. Where the event that gives rise to the declaration of *market intervention* occurs in one *grid* and does not affect the other *grid/s*, the *System Operator* shall declare *market intervention* in the affected *grid* only (i.e., regional declaration).

16.6 Dispatch Scheduling and Implementation

16.6.1 The *System Operator* shall be responsible for *dispatch* scheduling and implementation during the period when the *market suspension* or *market intervention* is in effect.

16.6.2 Pursuant to *WESM Rules* Clauses 6.5.2.1 and 6.6.5.1, the actions that the *System Operator* may take shall include, but shall not be limited to, the following:

- a. Increase or decrease the *generation* or supply *capability* such as issuance of *emergency* instructions to all available but not committed *generating units* to *start-up*, *shutdown*, cancel *generating units* on testing or recall transmission equipment *outages*;
- b. Disconnect one or more connection points as considered by the *System Operator* to be necessary;
- c. Direct a *customer* to take such steps as is reasonable to immediately reduce its *load*;
- d. Constrain on or constrain off a *Generation Company*; and
- e. Require *WESM Participants* to do any reasonable act or thing, which the *System Operator* believes necessary in the circumstances.

16.7 Power System and Market Restoration

16.7.1 The *Market Operator*, the *System Operator* and the *Trading Participants* shall exert their best endeavors to implement the required corrective actions to restore the market and/or *power system* back to normal conditions at the soonest possible time.

16.7.2 The *Market Operator* and the *System Operator* shall coordinate their actions to restore the normal operations of the *grid* and the market.

16.7.3 Whenever necessary, the *System Operator* and the *Market Operator* shall render operations using their respective Emergency Back-up Systems (EBS) to ensure continuing operations of the *System Operator* Energy Management System (EMS) and the *WESM MMS*.

16.7.4 System status report of the significant events occurring during the restoration of the *power system* or the market to normal operations shall be issued to the *Trading Participants*.

16.8 Market Resumption

16.8.1 **Market Resumption after a Market Suspension.** When the *ERC* lifts the suspension of the market, the operations of the market will resume at the soonest possible time following receipt by the *Market Operator* from the *ERC* of the notice lifting the *market suspension*. If the cause of the *market suspension* is the occurrence of a natural calamity, the *Market Operator* or the *System Operator* may recommend to the *ERC* the lifting of the *market suspension* if the effects of the calamity on the market or the *grid* has already been resolved.

16.8.2 Market Resumption after Market Intervention. Once the conditions that triggered the *market intervention* has been resolved, the *market intervention* shall be lifted by the *System Operator*.

- a. If the event that gave rise to the *market intervention* pertains to market failure or market operations, the *Market Operator* shall immediately notify the *System Operator* that the condition has already been resolved and that the declaration of *market intervention* can already be lifted. Immediately upon being notified, the *System Operator* shall declare the lifting of the declaration of *market intervention*.
- b. If the event that gave rise to the *market intervention* pertains to the *grid* or the operations of the *System Operator*, the *System Operator* shall immediately notify the *Market Operator* that the condition has already been resolved and that it is lifting the declaration of *market intervention*.

16.8.3 Upon being notified of the lifting of the declaration of *market intervention* or *market suspension*, the *Market Operator* shall immediately notify the *Trading Participants* of the resumption of the market and the specific *dispatch interval* at which trading in the *WESM* shall resume. The notice to *Trading Participants* shall include a notice to submit initial *bids* or *offers*.

16.9 Settlement of Market Transactions/Administered Price

Spot market transactions during the *dispatch intervals* when the *market suspension* or *market intervention* is in effect shall be settled in accordance with the Administered Price Determination Methodology approved by the ERC.

16.10 Report on Market Intervention or Market Suspension

16.10.1 Upon market resumption, the *System Operator* and the *Market Operator* shall prepare and submit to the *PEM Board*, the *ERC* and the *DOE* a detailed report containing, as minimum, the following information:

- a. Description of the circumstances that gave rise to the *market intervention* or *market suspension*;
- b. Steps taken to maintain operations and, in case of intervention, the steps taken to correct the situation; and
- c. Conclusions and recommendations for avoiding similar *market intervention* in the future.

16.10.2 In accordance with *WESM Rules* Clauses.6.9.4 and 6.9.5, the *Market Surveillance Committee* shall render to the *PEM Board*, *DOE* and the *ERC* a report on the *market intervention* or *market suspension* containing its assessment of the following:

- a. The adequacy of the relevant provisions of the *WESM Rules* in relation to the event or events which occurred;
- b. The appropriateness of the actions taken by the *System Operator* and the *Market Operator* in relation to the event or events that occurred; and

- c. The costs incurred by the *WESM Members* as a consequence of responding to the event or events.

16.11 Communications and Notifications

16.11.1 The *Market Operator* shall relay notices and advisories on emergency-related incidents and declaration of *market suspension* or *market intervention* and market resumption to the *Trading Participants* through any of the following means, whichever is applicable and available:

- a. Posting in the *market information website*;
- b. Email;
- c. Digital Telephone System; or
- d. Commercial telephone lines (land lines or mobile)

16.11.2 All communications through the aforementioned media shall be recorded for purposes of audit and surveillance.

16.12 Other Procedures

To complement the procedures set out in this Dispatch Protocol, the *System Operator* and the *Market Operator* shall formulate and maintain the following procedures:

- a. *System Operator*:
 - System *Emergency* and Restoration Procedures
 - EMS Disaster Recovery Procedures
- b. *Market Operator*:
 - *MMS* Disaster Recovery Procedures
 - Business Continuity Plan

16.13 Process Flows

16.13.1 The procedures to be carried out during *emergency* condition are intended to mitigate the effects of *emergencies* or *force majeure events*, facilitate restoration to normal operation and account for all actions and decisions taken during emergencies.

16.13.2 The detailed procedures leading to and during *market intervention* are set out in the following flowcharts:

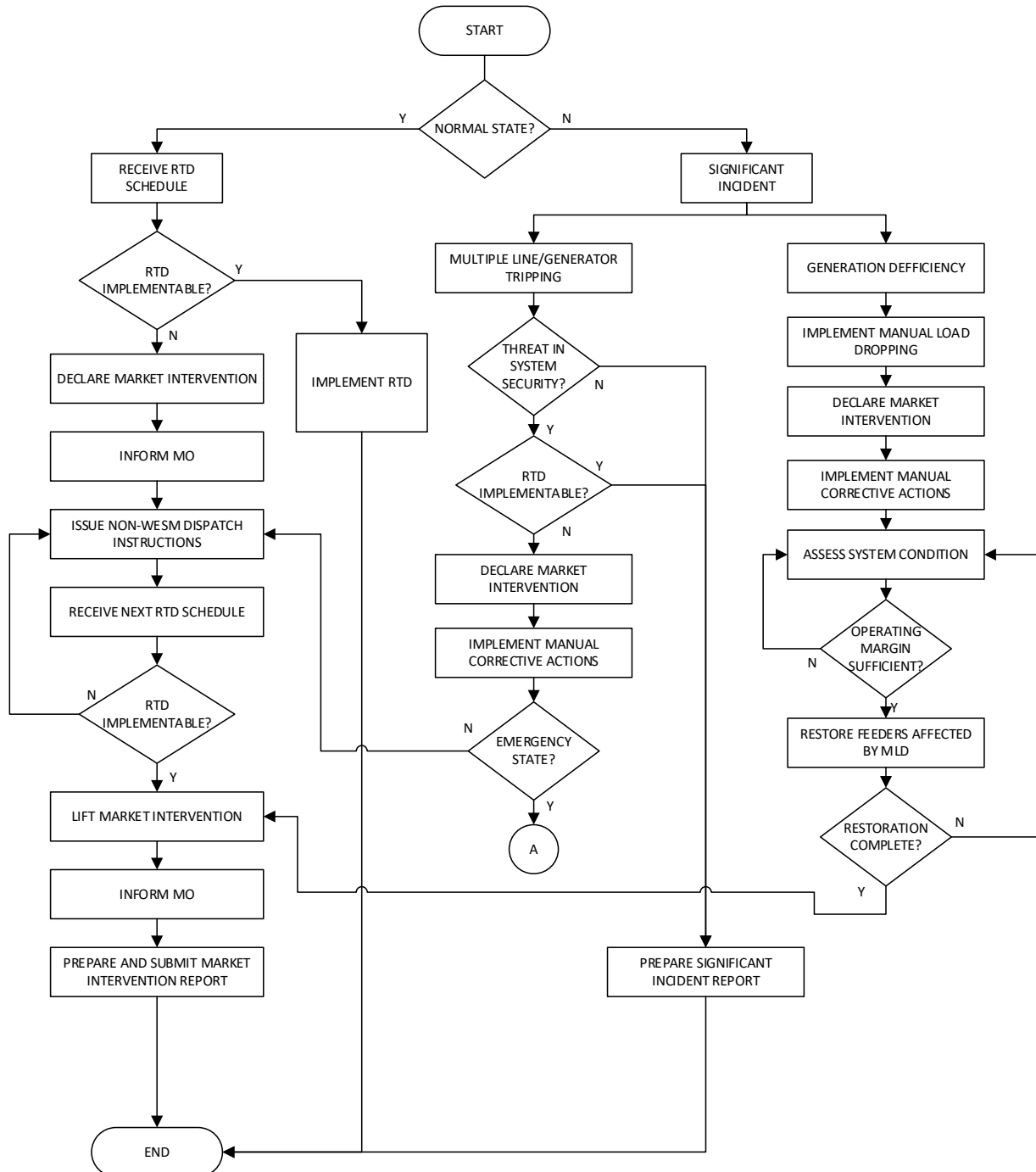
MARKET INTERVENTION AND SUSPENSION
A. SYSTEM OPERATOR PROCEDURES ON MARKET INTERVENTION

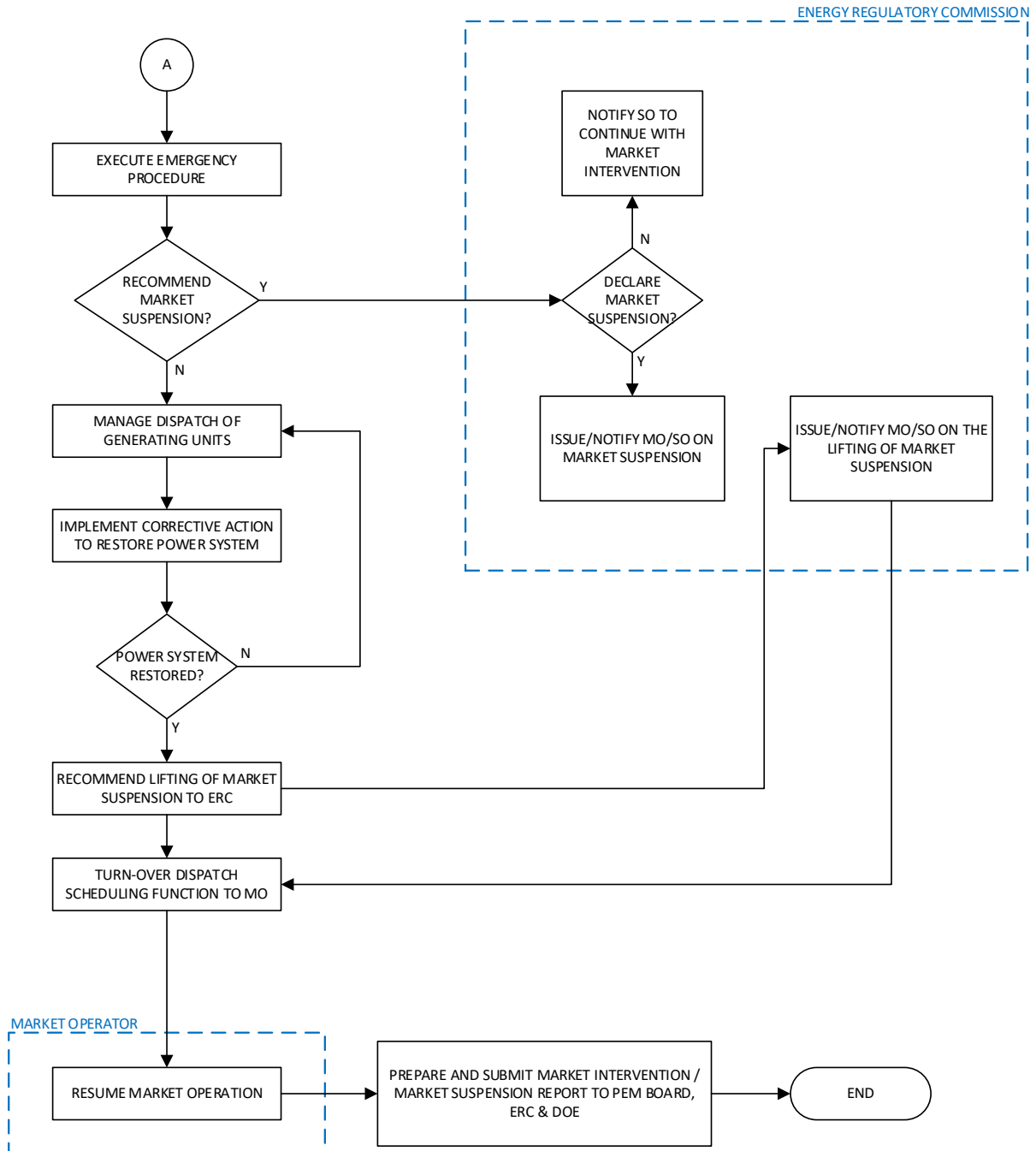
MARKET INTERVENTION AND SUSPENSION
B. SYSTEM OPERATOR PROCEDURES ON MARKET SUSPENSION

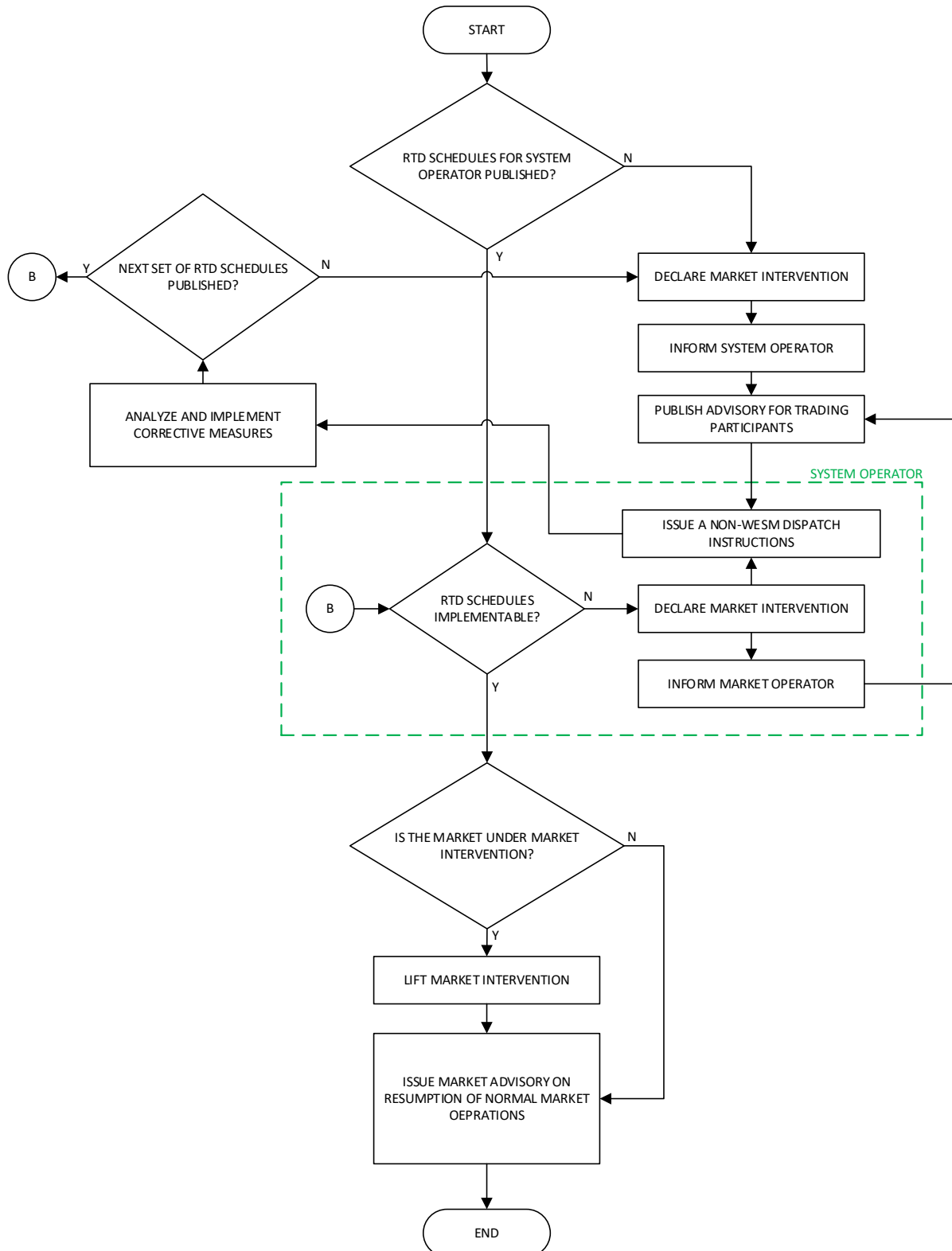
MARKET INTERVENTION AND SUSPENSION
C. MARKET OPERATOR PROCEDURES ON MARKET INTERVENTION

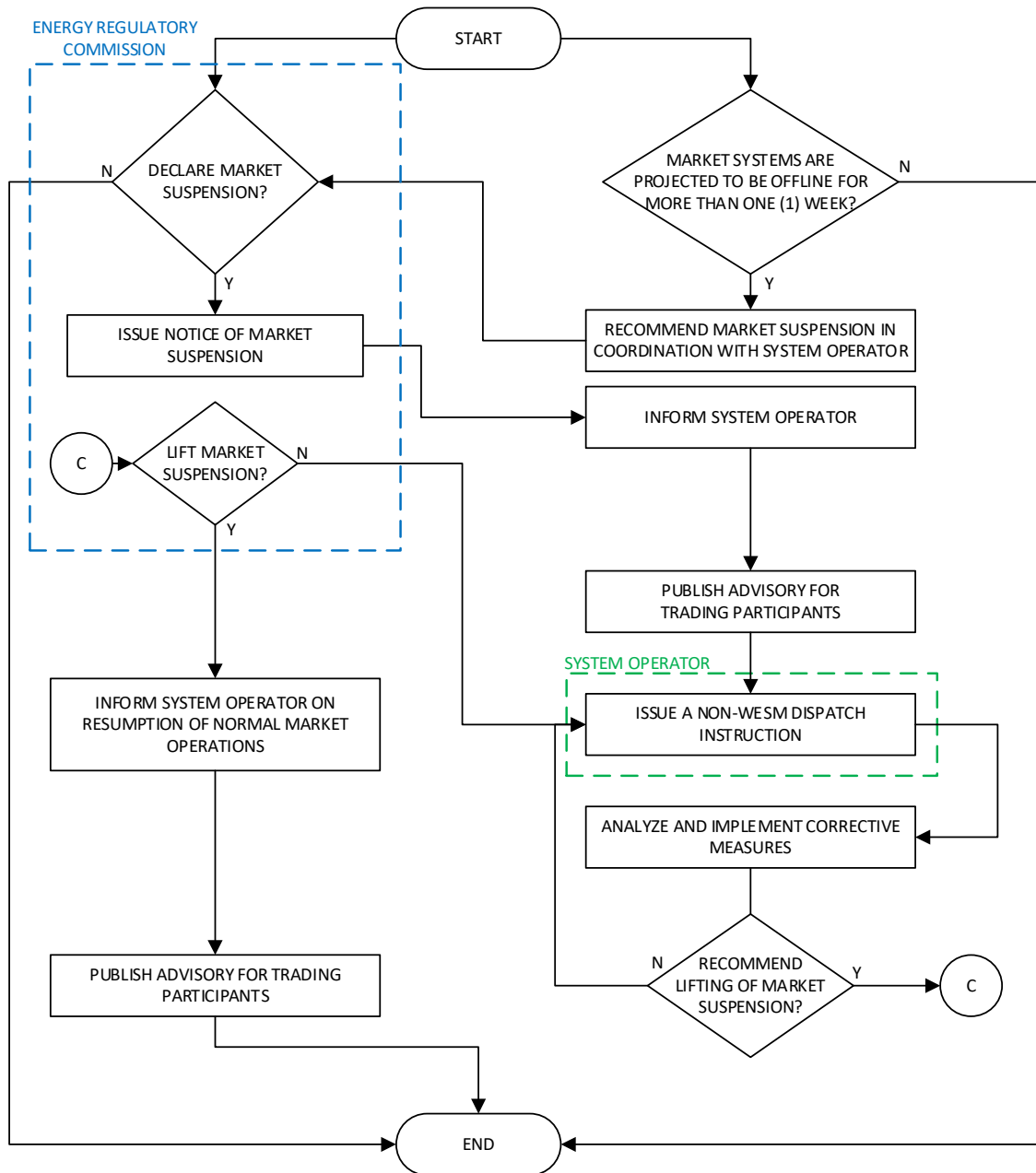
MARKET INTERVENTION AND SUSPENSION
D. MARKET OPERATOR PROCEDURES ON MARKET SUSPENSION

SECTION 17 MANAGEMENT OF MUST-RUN UNITS**17.1 Overview**

- 17.1.1 *WESM Rules* Clause 6.6.1 states that the *System Operator* shall develop and periodically update the *system security* and reliability guidelines in consultation with *WESM Participants* and the *Market Operator*. With this, *Must-run units (MRUs)* were introduced as *generating units* that are scheduled or *dispatched* in real-time to maintain the *security* and reliability of the *grid*.
- 17.1.2 *WESM Rules* Clause 3.5.13.1 permits the *System Operator*, in coordination with the *Market Operator*, to impose *constraints* on the power flow, *energy generation* of a specific facility in the *Grid* to address *system security* and reliability of the *Grid*. On the other hand, relaxation of *constraints* on power flows, *energy generation* and *reserves* may also be implemented if the *Market Operator* is unable to generate a feasible *dispatch schedule*. For this purpose, the *System Operator*, in consultation with the *Market Operator*, is directed to develop the criteria and procedures for *dispatch* of *generating units* that are required to run as a result of the imposition or relaxation of *constraints*.
- 17.1.3 The *Market Operator* shall provide a *merit order table* to the *System Operator* to serve as a guide in selecting *generating units* that can be re-*dispatched* in the course of the operations of the *power system*.
- 17.1.4 The *merit order table* is the stacking, in an unconstrained manner, of scheduled and unscheduled capacities through the *market offers* submitted for the RTD *market runs*. *Energy offer* blocks submitted by *generator Trading Participants* for a particular *dispatch interval* are arranged from lowest to the highest priced *offer* block, without considering any *constraints*. The *merit order table* stacks *energy offers* into two groups, namely, the *energy offers* that were scheduled (or "*Offers Dispatched*") and *energy offers* that were not scheduled (or "*Offers Not Dispatched*").
- 17.1.5 The *System Operator* utilizes the *merit order table's* "*Offers Dispatched*" as a guide in determining which *generating units* may be constrained-off, whereas the *merit order table's* "*Offers Not Dispatched*" is a guide for determining which *generating units* may be constrained-on for a particular *dispatch interval*.
- 17.1.6 The *Market Operator* prepares a separate *merit order table* for each of the *grids* where the *WESM* is in commercial operation.
- 17.1.7 All *generators* re-*dispatched* in real-time by the *System Operator* shall be considered as a *must-run unit*.

17.2 Must-Run Unit Criteria

- 17.2.1 In an event where all available *Ancillary services* have been exhausted to address the threat in *system security*, the *System Operator* shall make use of the *MRUs* to ensure the reliability and *security* of the *grid*. The following operating criteria shall be observed:

- a. *System Voltage Requirement* – this refers to the required voltage control and reactive power which the *System Operator* may need to take into account for the reliability of the *Grid*.
- b. *Thermal Limits of Transmission Line and Power Equipment* – this refers to the *dispatch* limitations of *generators* affected by the actual condition of the *transmission lines* and/or power equipment.
- c. *Real-power Balancing and Frequency Control* – this refers to the *energy re-dispatched* to maintain the balance between supply and *demand*.

17.3 Considerations and Criteria for Selection of Must Run Units

17.3.1 The *System Operator* shall select and designate the *generating units* that will run as an *MRU* for any period, in accordance with the criteria set forth in this section.

17.3.2 The criteria and considerations for selection of an *MRU* will depend on the reason for the designation of the *MRU*, as detailed in the table below.

Table 9. Criteria and Considerations for Selection of MRUs

<u>MRU Criteria</u>	<u>Considerations for Qualifications/Selection of Must-run units</u>
<p>System Voltage Requirement refers to the required voltage control and reactive power which the <i>System Operator</i> may need to take into account for the reliability of the <i>Grid</i></p>	<ul style="list-style-type: none"> • Generating unit/s run as <i>MRU</i> shall provide/absorb reactive power support in accordance with its corresponding reactive power capability curve to address under/over voltage problem. • Power plants with reactive power <i>generation/</i> absorption capability. • The use of <i>MRU</i> shall be based on the location where voltage problem exists
<p>Thermal Limits of Transmission Line and Power Equipment refers to the <i>dispatch</i> limitations of <i>generators</i> affected by the actual condition of the <i>transmission lines</i> and/or power equipment.</p>	<ul style="list-style-type: none"> • Generating unit/s called to run as <i>MRU</i> to ensure the <i>security</i> and reliability of the <i>grid</i>.
<p>Real-power Balancing and Frequency Control refers to the <i>energy</i> required to maintain the balance between supply and demand.</p>	<ul style="list-style-type: none"> • The <i>System Operator</i> issues <i>re-dispatch instruction</i> to the Generating unit/s with fast ramp rate capability to constrain-on its output to immediately address threat in <i>security</i> and reliability of the <i>grid</i>. • During islanding operation or whenever a portion or part of the <i>grid</i> is isolated, the <i>System Operator</i> may require the Generator/s to come on-line to supply the corresponding demand of the localized portion of the isolated part of the <i>grid</i>

17.4 MRU Scheduling and Dispatch Procedures

- 17.4.1 The *Generating unit/s* identified and instructed by the *System Operator* as *MRUs* shall be based on the *security* assessment conducted by the *System Operator*.
- 17.4.2 *Generators* whose generating plants are instructed as *MRUs* must immediately and strictly comply with the corresponding *dispatch instructions* of the *System Operator*.
- 17.4.3 The following flowchart outlines the treatment of *Must-run units* during the scheduling and *dispatch*.

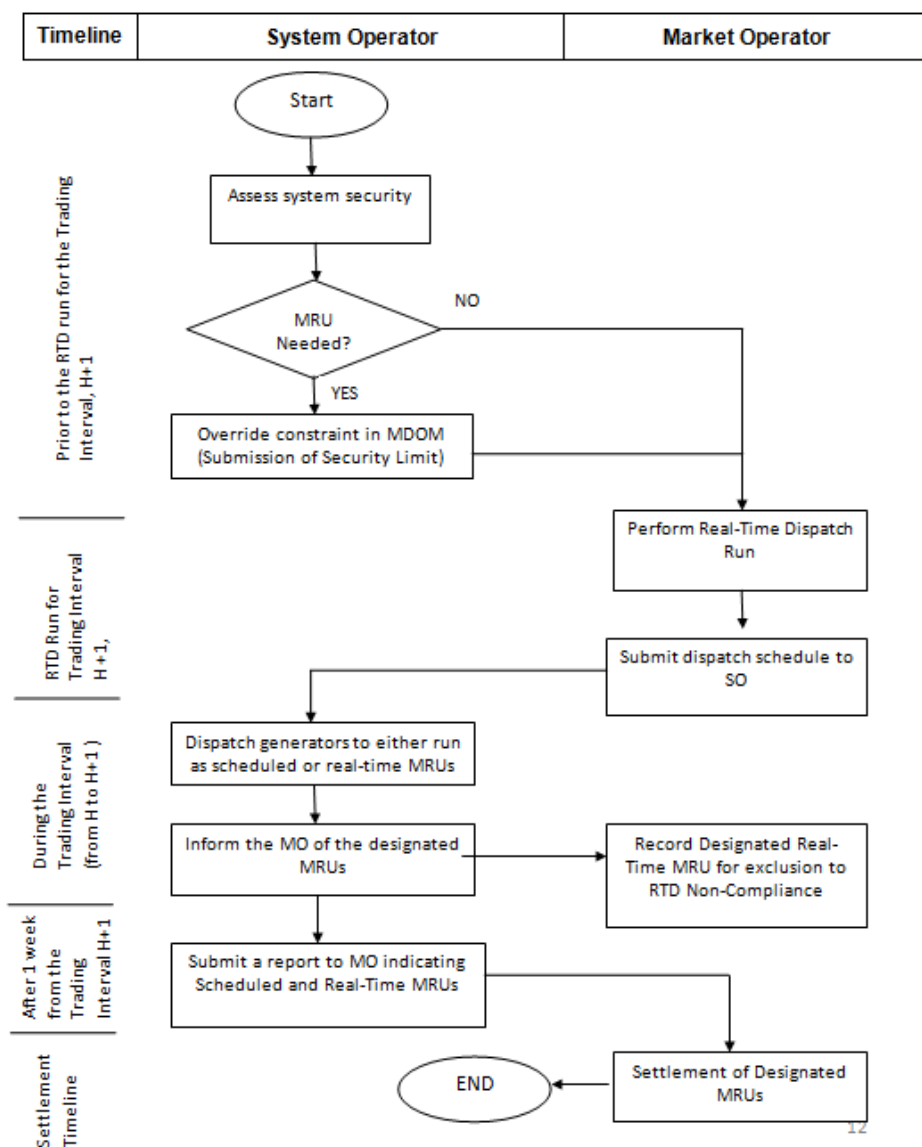

Figure 8. Procedure for the Scheduling and Dispatch of Must-run units

17.5 Reporting and Publication

- 17.5.1 Each *generator* shall validate all the data related to *MRU* contained in the *Dispatch Deviation Report* as published by the *Market Operator* in the *Market information website*. Any discrepancy in these reports shall be reported by the *Generator* to the *Market Operator* within two weeks after the *Market Operator's* publication of these reports. Failure by the *Generator* to report to the *Market Operator* any discrepancy within the period defined herein shall render the *MRU* data relative to the *Generator* final.

SECTION 18 EXCESS GENERATION

18.1 Overview

- 18.1.1 *WESM Rules* Clause 3.9.8.1 states that “should either the *Dispatch Optimization*, or any *Market projection*, indicate *Excess Generation* at any Node, the *Market Operator* shall advise the *System Operator* that it may be necessary to require some *Generating Systems* to shut down.
- 18.1.2 *Excess generation* is a situation where demand has reached a critical low level that selected generating plants may be forced to shut-down by the *System Operator* to avoid exceeding the allowable limit in system *frequency* deviation which can result to inadvertent power flow, system *stability* issues and transmission *constraints*. *Excess generation* is clearly a threat to the *security* and reliability of the *power system*.
- 18.1.3 *Excess generation* is encountered in the *power system* in the following typical scenarios:
- a. Instantaneous or sudden loss of significant amount of *load* demand in the *power system*
 - b. *Power system* reaches off-peak condition whereby demand is so low that it is still below the minimum generating level of the *generators* synchronized in the *power system*
- 18.1.4 *WESM Rules* Clause 3.9.8.2 states that “where necessary to shut down *Generating Systems* under Clause 3.9.8.1, the *System Operator* shall manage dispatching while the *Market Operator* shall manage pricing in accordance with the procedures to be developed by the *Market Operator*, in consultation with the *System Operator* and *WESM Participants*, and subject to approval by the *PEM Board*”. The procedures shall also take into account the occurrence of *excess generation* when the *System Operator* has exhausted all mitigating measures to address the *excess generation*.

18.2 Responsibilities

18.2.1 The *Market Operator* shall be responsible for the following:

- a. Prepare the *market projections* based on the *WESM Timetable* incorporating the inputs provided by the *System Operator* in accordance with Section 7 of this Dispatch Protocol.
- b. Prepare the *real-time dispatch schedules* based on the *WESM Timetable* incorporating the inputs provided by the *System Operator* in accordance with Section 7 of this Dispatch Protocol.
- c. Coordinate and inform the *System Operator* and *Trading Participants* of any indication of *excess generation* based on the results of the *day-ahead projections (DAP)*.
- d. Prepare *WESM merit order table* and submit to the *System Operator*.
- e. If necessary, issue a market advisory should the *real-time dispatch* encounter the *excess generation* in the pricing and scheduling results.

18.2.2 The *System Operator* shall be responsible for the following:

- a. Determine the level of threat to *system security* based on *System Security and Reliability Guidelines*.
- b. Coordinate with the *Market Operator* and provide necessary information which will be utilized in the *real-time dispatch* to mitigate or arrest possible *excess generation* condition as indicated in the *DAP* prepared by the *Market Operator*.
- c. Coordinate with the *Market Operator* for the imposition of over-riding *constraint* limit for certain generating unit/s that would be required not to be shut down.
- d. Implement Emergency Procedures and provide instructions to *generating units* not elected as must-run to *shutdown*, as maybe necessary, based on the *System security* and *Reliability Guidelines* and *WESM merit order table (WMOT)* provided by the *Market Operator*.

18.2.3 *Trading Participants* shall be responsible for the following:

- a. Review *generating units'* availability, maintenance schedule, *energy* and ramping limits in anticipation of the off-peak condition in the *power system*.
- b. Submit *offers* for intervals with expected low demand.
- c. Coordinate and implement re-dispatch instructions and *generator* tripping as instructed by the *System Operator*. In case of *excess generation*, the *Trading Participants* shall be responsible for executing the *dispatch instructions* from the *System Operator* when required to constrain-off (i.e. decrease the output to Pmin or from online to be *shutdown*) with due consideration to power quality, reliability and *security* of the *grid*.

18.3 Managing Excess Generation for the Next Day

18.3.1 There is an impending *excess generation* when the resulting price in the *day-ahead projection* run is equivalent to the offer floor price and the aggregate unscheduled Technical Pmin of generating units with floor price offers is greater than or equal to the *secondary reserve* requirement.

- 18.3.2 The *Market Operator* shall immediately advise the *System Operator* and *Trading Participants* through system advisories of impending *excess generation* for the affected periods of the next day, and shall publish the same in the MPI.
- 18.3.3 The *System Operator* may submit *over-riding constraint* limits for *generating units* that are required to operate as *must-run units* during the period of the impending *excess generation*.
- 18.3.4 *Trading Participants* may revise their *bids* and offers and shall exercise prudence on their *bids* and *offers* with regard to market integrity and *power system security* for intervals with impending *excess generation* periods by:
- a. *Customers* – Assessing their electricity consumption
 - b. *Generators* – Assessing the capacity and mode of operation of their *generating units*.
- 18.3.5 Should there be any indication of an *excess generation* four (4) hours prior to the affected hour, the *System Operator* shall prescribe the shut-down of generating units based on the *WESM excess generation merit-order table* provided by the *Market Operator*. The excess generation merit-order table shall be based on the average loss factor computed every six (6) months.

18.4 Managing Excess Generation In Real-Time

- 18.4.1 If *excess generation* is still observed in the *real-time dispatch*, then the *System Operator* shall follow the *emergency* procedures set forth in Section 20.4.2 of this Dispatch Protocol.

18.5 Provision of Reports

- 18.5.1 The *System Operator* shall be responsible for preparing reports concerning the technical implication of the anticipated *excess generation* event and/or actual *excess generation* incident.
- 18.5.2 The *Market Operator* shall be responsible for preparing impact of the anticipated *excess generation* event and/or actual *excess generation* incident to the *WESM*

SECTION 19 PROCEDURES FOR LOAD SHEDDING**19.1 Overview**

19.1.1 *WESM Rules* Clause 3.9.1 states that the *System Operator* may direct a *WESM Member* to conduct *load shedding* in response to the following:

- a. An overall shortage of energy in a region specified in the market network model; or
- b. Other network conditions, as determined by the *System Operator* in accordance with the procedures established under the *Grid Code* and *Distribution Code*.

19.1.2 *WESM Rules* Clause 3.9.2 states that the *Market Operator* shall inform the *System Operator* on the presence of nodal loss of *load* based on the results of the *day-ahead projections* and *real-time dispatch*, particularly for nodal *loads* that are expected to be reduced by the presence of non-zero nodal *energy constraint* violation variables or *nodal energy dispatch prices* which are expected to be equal to, or exceed, *nodal VoLL* at any *customer market trading nodes* in the *market network model*.

19.1.3 *WESM Rules* Clause 3.9.3 states that the *System Operator* shall:

- a. If informed by the *Market Operator* under *WESM Rules* clause 3.9.2, act immediately in accordance with the *security* and reliability guidelines to mitigate the effects of the presence of the nodal loss of *load*, or any other considerations which the *System Operator* considers relevant under the *Grid Code* and *Distribution Code* and any other applicable regulatory instrument; and
- b. Initiate *load shedding* in response to any other circumstances which it reasonably considers necessitates such action under the *Grid Code* and *Distribution Code* or any other applicable regulatory instrument.

19.1.4 In accordance with the *Grid Code* (GO 6.6.8.6), *demand control* shall be implemented to reduce the demand of the *grid* when:

- a. The *System Operator* has issued a Red Alert notice due to *generation* deficiency or when a *Multiple Outage Contingency* resulted in *Islanding Operation*;
- b. The *System Operator* has issued *Demand Control Imminent Warning Notice* due to *generation* deficiency; or
- c. There is an imminent *overloading* of a line or equipment following the loss of a line, equipment or generating plant that poses threat to *system security*;

Demand control shall include the following:

- a. *Automatic Load Dropping (ALD)*;
- b. *Manual Load Dropping*;
- c. Demand reduction on instruction by the *System Operator*; and
- d. *Voluntary Demand Management*.

19.1.5 In accordance with *Distribution Code* (6.6. and 6.6.3), the *Distributor* shall prepare its *ALD* program in consultation with the *System Operator*. The *Distributor's demand* that is subject to *ALD* shall be split into rotating discrete MW blocks. The *System Operator*

shall specify the number of blocks and the under-frequency setting for each block. For *manual load dropping*, the Distributors shall, in consultation with the *System Operator*, establish a priority scheme for *manual load dropping* based on equitable load allocation.

- 19.1.6 For clarity in the procedures to be followed by the *System Operator*, the terms *automatic load dropping* and *manual load dropping* shall be used. Also, the procedures were formulated separately as the two events have different courses of action to be undertaken by the *System Operator*.
- 19.1.7 For the *System Operator*, *load shedding* is instigated when the *demand* for electricity exceeds the supply capacity of the system, to prevent *voltage sags* or *voltage instability* and to restore transmission voltages to allowable limits, and/or to prevent the overloading of line or equipment. It is resorted to when available options to address the supply-demand imbalance, severe under-voltage or impending *voltage sag* or *voltage instability* condition, and/or line/equipment overloading have been exhausted.
- 19.1.8 Pursuant to *WESM Rules* Clause 3.9.7, the *System Operator* shall manage all aspects of dispatching while the *Market Operator* shall manage pricing during periods when *load shedding* is required in accordance with the detailed procedures to be developed by the *System Operator* and the *Market Operator*, in consultation with *WESM Participants*, and subject to approval by the *PEM Board*.

19.2 Responsibilities

19.2.1 The *System Operator* shall:

- a. Establish the demand requirement for load shedding in order to limit the consequences of a major loss of generation in the grid.
- b. Recognize the operating state to be in an emergency condition when it determines the existence of a situation, which has an adverse material effect on electricity supply or which poses as a significant threat to system security.
- c. Issue a Red Alert Warning as may be necessary
- d. Intervene in the spot market if either (a) an emergency, (b) a threat to system security, or (c) a force majeure event manifests in the grid.
- e. Prepare, implement, and monitor the compliance of WESM Members with their load shedding schedule.
- f. Give directions and coordinate with the Market Operator and WESM Members the actions to be taken in order to restore normal operation of the power system.
- g. Provide the necessary notifications in accordance with the WESM Rules under clause 6.5.1.2.
- h. Establish a priority scheme for load shedding in consultation with Network Service Providers based on agreed priorities and equitable load allocation.
- i. Annually review the load shedding priority scheme established in consultation with Network Service Providers.

19.2.2 The *Market Operator* shall:

- a. Inform the *System Operator* of the presence of nodal loss of load under clause 3.9.2 of the *WESM Rules*.

- b. Coordinate actions with the *System Operator* in the resumption of the *spot market* to normal operation.
- c. Issue market advisory to *WESM Members*

19.2.3 The *WESM Members* shall:

- a. Comply with the *emergency* directions given by the *System Operator*, unless it reasonably believes that an *emergency* direction poses a real and substantial risk of damage to its equipment, to the safety of its employees or the public, or if undue injury to the environment.
- b. Provide information required by the *System Operator* in order to address the *emergency* condition.
- c. Ensure that its *generating units* remain in synchronism for operating conditions as specified under the *Grid Code*.
- d. *Network Service Providers* shall have a *load shedding* program prepared in consultation with the *System Operator* with established priority and based on equitable *load* allocation.

19.3 Preconditions / Pre-Requirements

19.3.1 The *nodal energy dispatch prices* are reflective of the *nodal VoLL* price based on *market projections* or *dispatch* optimization performed prior to commencement of each *dispatch interval*.

19.3.2 Within a *dispatch interval*, a power supply shortfall in the electric system, a region, or a *node* unexpectedly happened.

19.3.3 If either (a) an *emergency*, (b) a threat to *system security*, or (c) a force majeure event manifests in the *grid*.

19.3.4 The *grid* is under Red Alert.

19.4 Procedure for Manual *Load Shedding*

The procedure for Manual *Load Shedding* is established in the *emergency* procedures set in section 20.4.5 of this Dispatch Protocol.

SECTION 20 EMERGENCY PROCEDURES
--

20.1 Overview

- 20.1.1 Maintaining continuous power supply to the customers is the primary concern in the Philippine electricity industry. Thus, system should account for minimal interruption of service to the customers. However, even with the latest state-of-the-art design, planning, and/or maintenance criteria, it is inevitable that the system will experience disturbances. Hence, the system should be able to react to and withstand any system disturbances. It implies that the system will remain intact even after *outages* or other equipment failures occur.
- 20.1.2 The *System Operator* and *Market Operator* are in the forefront in ensuring that the *power system* is reliable and secure. Scheduling of *ancillary services* and system reserve requirements are being done by *System Operator* while the *Market Operator* considers the N-1 security criteria requirement of the *Grid Code* in their *dispatch* simulations in order to make the system more reliable and secure.
- 20.1.3 To further improve system reliability and security, *System Operator* has also installed various equipment and protection schemes throughout the power system. Redundant protection devices are installed and are continuously being upgraded (to numerical devices) to ensure that system disturbances could be isolated the fastest possible time even if there is a failure of one fault clearance system component. *Automatic load dropping (ALD)* scheme are in place to arrest deterioration of the system that could eventually lead to system collapse. *System integrity protection scheme (SIPS)* are also in place in identified critical lines to further increase the system's N-1 security criteria to N-2. This is done to arrest *cascading outages* that could eventually also lead to system collapse. Contingency analysis of the system is continuously done by the national control center/regional control center personnel to determine the best possible operator action in case of any unplanned *outage*.
- 20.1.4 However, in reality, even the best protection system, contingency planning and preparation could be derailed by an incident or a series of incidents endangering the system and placing the system in an extreme state condition that would require operator intervention. During this condition, the system is considered to be in an *emergency state*.
- 20.1.5 The *System Operator* is responsible for giving directions and coordinating actions, which are to be undertaken by *WESM Participants* and *Market Operator* when there is *market intervention*. During *emergency*, the *System Operator* and *Market Operator* will coordinate their actions to restore normal operation of the *power system* and the market.
- 20.1.6 The *System Operator* will declare an *emergency* when it determines the existence of a situation which has an adverse material effect on electricity supply or which poses as a significant threat to *system security*.
- 20.1.7 *Emergency procedures* are the actions to be taken by *WESM Participants* and *Market Operator* at the direction of the *System Operator* to maintain *system security* and/or avert or reduce the effect of an adverse system condition. These are the procedures

undertaken to restore the *power system* to a satisfactory operating state immediately after an *emergency*.

20.1.8 *WESM Rules* Clause 3.8.2.1 provides that the *System Operator* will intervene, where necessary, as provided during system *emergencies*.

20.2 Scope and Purpose

20.2.1 This document prescribes general actions that must be undertaken by all *WESM Participants*, *System Operator* and *Market Operator* to restore the *power system* to a satisfactory operating state immediately after an *emergency* in the Luzon, Visayas and Mindanao *power systems*.

20.2.2 These guidelines are based on existing practices, the *Grid Code* and *Distribution Code* requirements and developed in accordance with Clause 6.3.2.4 of the *WESM Rules* which states that the *System Operator* in consultation with the *Market Operator* will develop appropriate *emergency* procedures and publish the details of the approved procedures in accordance with the *Grid Code* and *Distribution Code*, subject to approval of the *PEM Board*.

20.2.3 These guidelines apply to the following *WESM Members*:

- a. *Market Operator*;
- b. *System Operator*;
- c. *Generation Companies*;
- d. *Ancillary Service Providers*;
- e. *Distribution Utilities*;
- f. *Suppliers*;
- g. Bulk Consumers / *End-users*; and
- h. Other similar entities, authorized by the *Energy Regulatory Commission (ERC)* to become members of the *WESM*.

20.3 Responsibilities

20.3.1 The *System Operator* shall:

- a. Give *emergency* instructions or directives when it determines the existence of a situation which has an adverse material effect on electricity supply or which poses as a significant threat to *system security*.
- b. Prepare and submit a significant incident report to the *ERC*, *PEM Board*, *DOE*, *Grid Management Committee* and the *Market Operator*.
- c. May from time to time specify procedures for communicating the existence of an *emergency* and all relevant information relating to the *emergency* to the *WESM Participants*.
- d. Review and update the *emergency* procedures in consultation with the *Market Operator* as the need arises.

20.3.2 The *WESM Participants* shall:

- a. Notify the *System Operator* as soon as practicable of:
 1. Any event or situation of which the *WESM Participant* becomes aware where, in the reasonable opinion of the *WESM Participant*, that event or situation is of a kind described as an *emergency*, and
 2. Any action taken by the *WESM Participant* under its safety procedures otherwise in response to that event or situation, in accordance with the *Grid Code* and *Distribution Code*.
- b. Ensure that its safety plan permits it to comply with *emergency* directions.
- c. Comply with any *emergency* direction given by the *System Operator*, including *emergency* directions requiring the disconnection of equipment from a *transmission system* or *distribution system* for reliability purposes, unless the *WESM Participants* reasonably believes that an *emergency* direction given by the *System Operator* poses a real and substantial risk of damage to its equipment, to the safety of its employees or the public, or of undue injury to the environment.
- d. Notify the *System Operator* if it intends not to follow the *emergency* direction for any of the reasons described in item c above.
- e. Comply with the *System Operator's* direction to the fullest extent possible without causing the harms described in item c above.

20.4 Emergency Procedures

20.4.1 Emergency Procedures during Overload

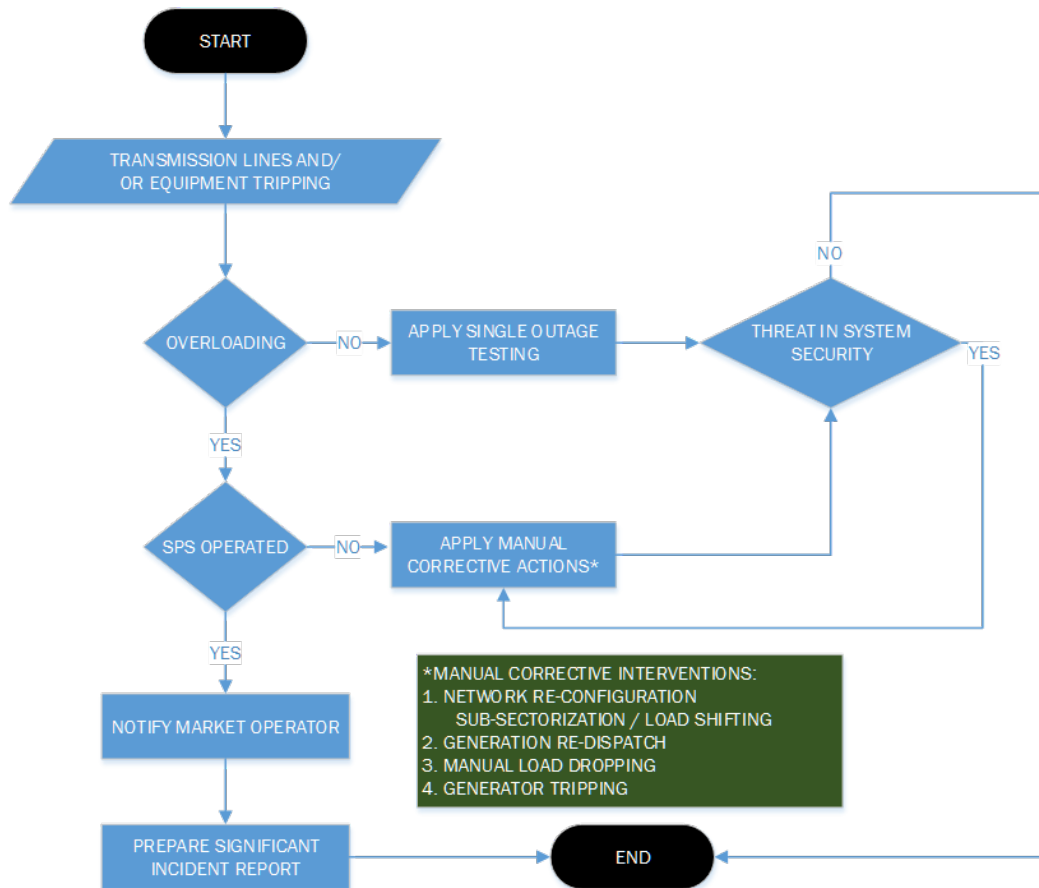

20.4.2 Emergency Procedures during Excess Generation

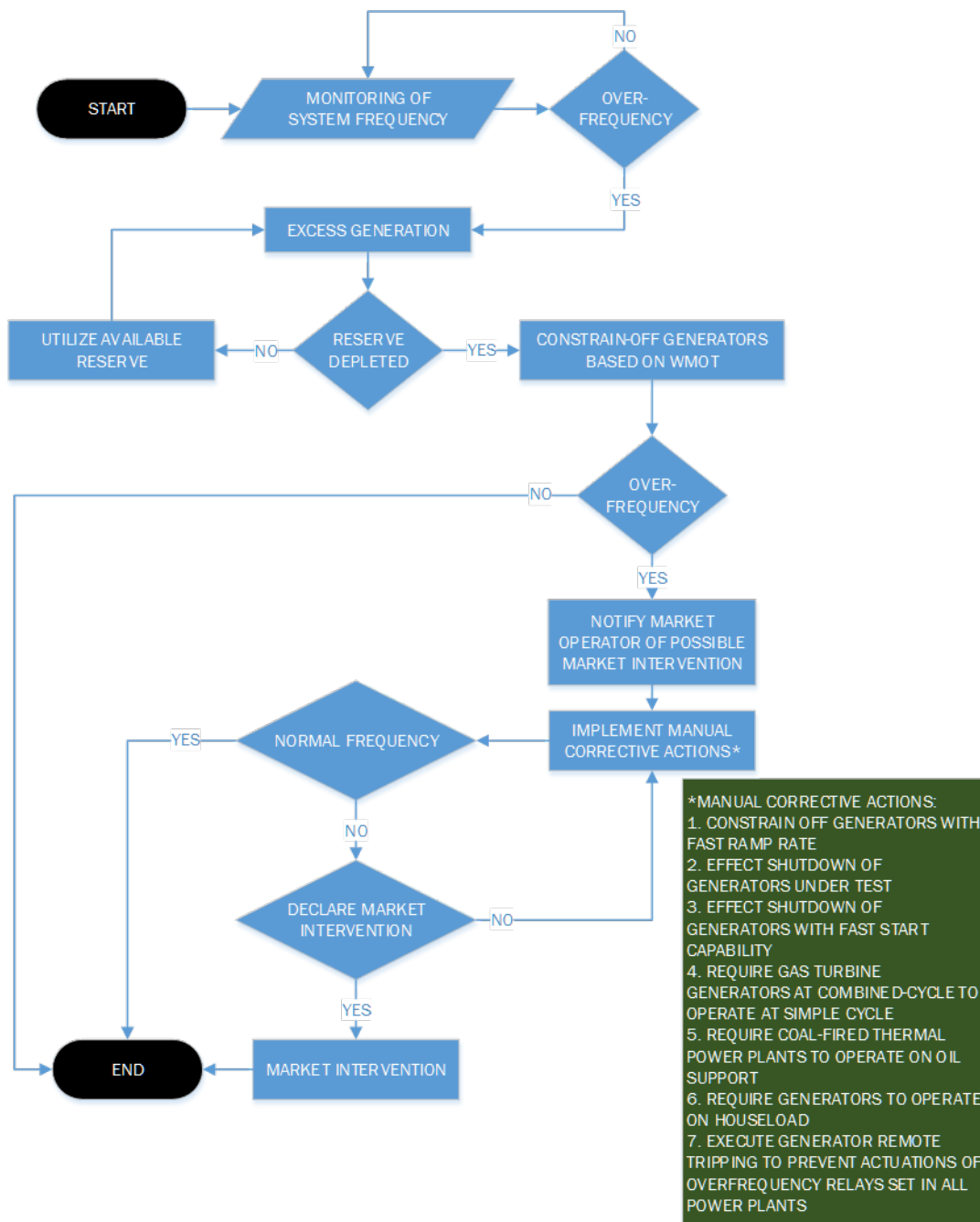

20.4.3 Emergency Procedures during Under Voltage Condition

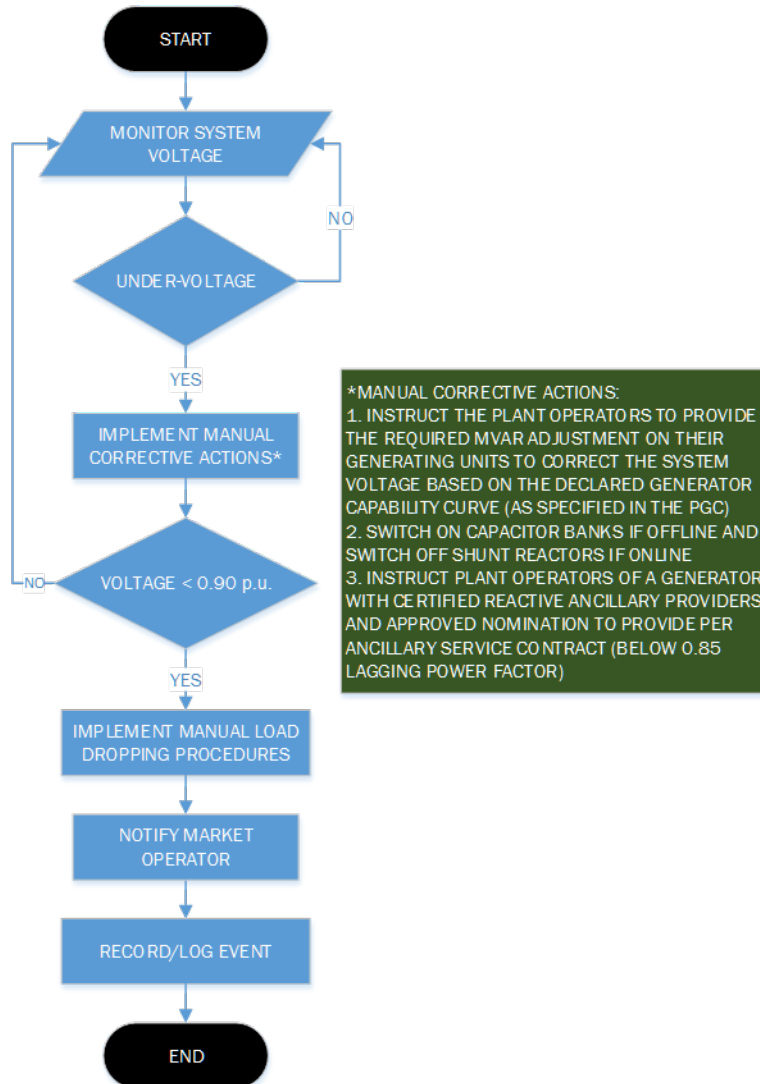

20.4.4 Emergency Procedures during Over Voltage Condition

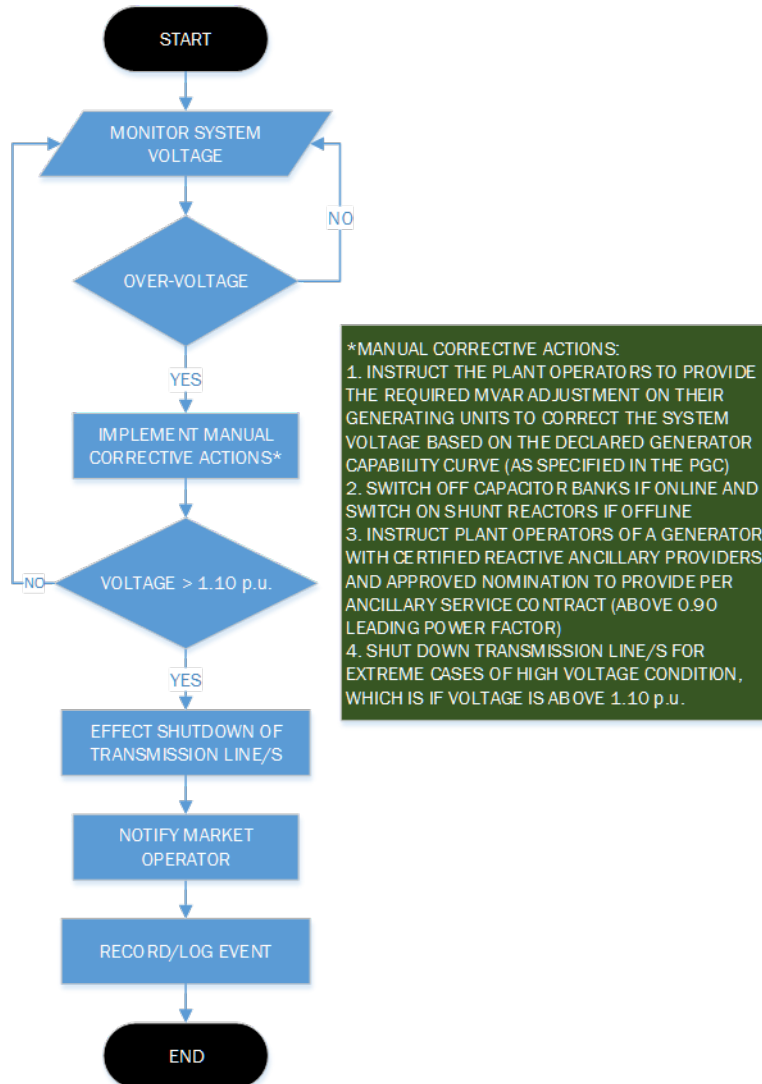

20.4.5 Emergency Procedures during Manual Load Dropping

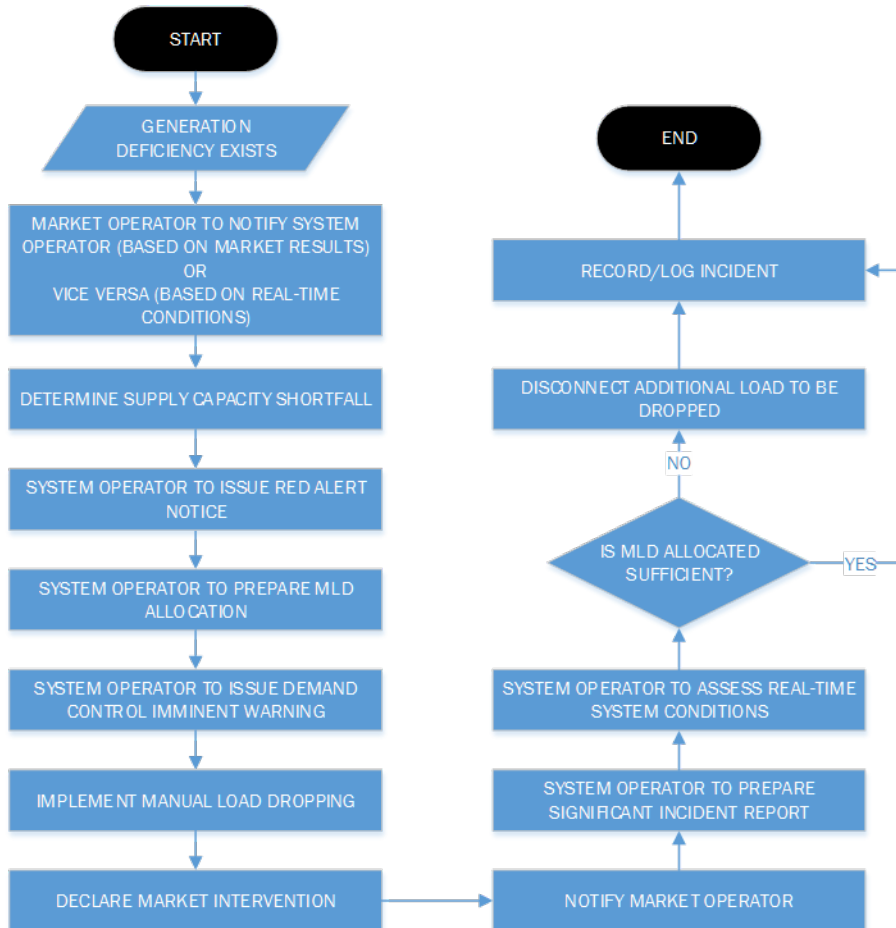

SECTION 21 AMENDMENT, PUBLICATION AND EFFECTIVITY**21.1 Amendments**

- 21.1.1 The *Market Operator*, the *System Operator*, or any *WESM Member*, or interested entity may propose amendments to this Dispatch Protocol by submitting proposals to the *WESM Rules Change Committee*, following procedures for changes to *Market Manuals* set out in the *WESM Rules* and in the relevant *Market Manual*.
- 21.1.2 The *Market Operator* or the *System Operator* shall initiate amendments to this Dispatch Protocol as may be necessary.
- 21.1.3 Amendments to this Dispatch Protocol shall be approved by the Philippine Electricity Market Board, following the procedures for changes to *Market Manuals* set out in the *WESM Rules* and in the relevant *Market Manual*.

21.2 Publication

This Dispatch Protocol, as it may be amended from time to time, shall be published in the *market information website* maintained by the *Market Operator*.

21.3 Effectivity

This Dispatch Protocol or any amendments thereto shall become effective upon approval of the DOE in accordance with *WESM Rules* Clause 8.6.4 the date of effectivity shall be indicated in this document.

SECTION 22 APPENDIX**Appendix A. Content Structure of *Market projections* Results for the *System Operator***

The *Market Operator* shall submit the following information on the results of the *market projections* to the *System Operator*.

- a. MW schedules for each resource in the *market projections*
- b. Market Requirements [forecasted *load* (or *energy* requirement) and *reserve* requirements] per region
- c. *Constraint* Violations

The following tables show the fields of each information to be transmitted to the *System Operator*.

a. Market projections Schedules	
Column Name	Description
START_TIME	Start Time of the Projected Hour (for WAP and DAP) or Dispatch interval
END_TIME	End/Target Time of the Projected Hour (for WAP and DAP) or Dispatch interval
RUN_TYPE	Describes the type of market run <ul style="list-style-type: none"> • WAP • DAP • HAP
MKT_PRODUCT	Describes the type of market product <ul style="list-style-type: none"> • “EN” for energy • “RU” for Regulation raise/upward • “RD” for Regulation lower/downward • “FR” for Fast Contingency Raise • “FL” for Fast Contingency Lower • “SR” for Slow Contingency Raise • “SL” for Slow Contingency Lower • “DR” for Delayed Contingency Raise • “DL” for Delayed Contingency Lower
RES_TYPE	Describes if the Resource is a generator or load <ul style="list-style-type: none"> • GEN • LD
RESOURCE_ID	Generator/Load Name as represented in the Market Management System
MW	MW schedule that is referenced to the End/Target Time

b. Market Requirements	
Column Name	Description
START_TIME	Start Time of the Projected Hour (for WAP and DAP) or Dispatch interval
END_TIME	End/Target Time of the Projected Hour (for WAP and DAP) or Dispatch interval
RUN_TYPE	Describes type of market run <ul style="list-style-type: none"> • WAP • DAP • HAP
MKT_PRODUCT	Describes type of requirement <ul style="list-style-type: none"> • “EN” for energy • “RU” for Regulation raise/upward • “RD” for Regulation lower/downward

b. Market Requirements	
Column Name	Description
	<ul style="list-style-type: none"> • “FR” for Fast Contingency Raise • “FL” for Fast Contingency Lower • “SR” for Slow Contingency Raise • “SL” for Slow Contingency Lower • “DR” for Delayed Contingency Raise • “DL” for Delayed Contingency Lower
REGION_ID	Region name with the specific market requirement
REQ_MW	MW schedule that is referenced to the End/Target Time

c. Constraint Violations	
Column Name	Description
START_TIME	Start Time of the Projected Hour (for WAP and DAP) or Dispatch interval
END_TIME	End/Target Time of the Projected Hour (for WAP and DAP) or Dispatch interval
RUN_TYPE	Describes type of market run <ul style="list-style-type: none"> • WAP • DAP • HAP
VIOLATION_TYPE	Describes the type of violation that occurred (i.e. Base Case Thermal, N-1 Contingency Thermal, under-generation, over-generation, etc.)
VIOLATED_NAME	Region, Equipment, or Load Name affected by Violation
VIOLATED_MW	MW Amount of Violation

Appendix B. Steps in Creating a Merit Order Table

This example uses the following data -

Resource ID	Price1	Quantity1	Price2	Quantity2	Price3	Quantity3
A	4	5	4	15	8	25
B	1	10	1	25		
C	7	15	7	30		

Note: The first block quantity (Quantity1) is the Pmin or minimum registered capacity of the generating unit. It is a price taker and the price at this first block (Price1) is not considered in the stacking of the WMOT.

Assuming that the demand is 50 MW, the resulting *energy* schedules shall be.

Resource ID	Schedule
A	10
B	25
C	15

The marginal plant is Generator A with a clearing price of PhP4.00/MWh.

1. Fetch the *generator ex-ante* schedules, nomination of *loading levels, projected outputs*, and the *generator energy offers*.

Energy Offer

Resource ID	Price1	Quantity1	Price2	Quantity2	Price3	Quantity3
A	4	5	4	15	8	25
B	1	10	1	25		
C	7	15	7	30		

Ex-ante Schedules

Resource ID	Schedule
A	10
B	25
C	15

2. Exclude *generating units* that are unavailable based from either the *outage* schedule or from the network configuration captured at *ex-ante*. *For this example, this step is not illustrated and all generating units included are scheduled.*
3. Sort the *offers* by *energy offer* blocks for each generating unit as follows -

- 3.a. If possible, split the *ex-ante* schedule of each generating unit based on its *energy offer* blocks. These blocks shall belong to the list of “**OFFERS DISPATCHED**”. The list should contain the Resource ID, MW, block, and price. For *generators* scheduled with no *offers*, these shall be included in the *WMOT* as price takers.

Resource ID	MW	Block	Price
A	5	1	Price_Taker
A	5	2	4
B	10	1	Price_Taker
B	15	2	1
C	15	1	Price_Taker

- 3.b. If there is a remaining *offered* quantity for a generating unit that is not scheduled, split this to the extent possible based on its *energy offer* blocks. These blocks shall belong to the list of “**OFFERS NOT DISPATCHED**”, and the list should contain the Resource ID, MW, block, and price.

Resource ID	MW	Block	Price
A	5	2	4
A	10	3	8
C	15	2	7

4. Create the **OFFERS DISPATCHED** *WMOT* as follows –

- a. Sort the list of *energy offer* blocks in the list starting with the lowest priced *offer* block at the bottom to the highest-priced *offer* block at the top, i.e., sorting using data on the Price column.

Resource ID	MW	Block	Price
A	5	2	4
B	15	2	1
C	15	1	Price_Taker
B	10	1	Price_Taker
A	5	1	Price_Taker

- b. For dissemination purposes, the price column is deleted in the **OFFERS DISPATCHED** list, so that the *WMOT* to be disseminated will contain the following information only -

Resource ID	MW	Block
A	5	2
B	15	2
C	15	1

Resource ID	MW	Block
B	10	1
A	5	1

- c. Add the scheduled *offer* blocks in MW and indicate the running total in the “Running Total” column. The running total is simply the incremental value based on the MW column and should start from the top of this list.

Resource ID	MW	Block	Running Total
A	5	2	5
B	15	2	20
C	15	1	35
B	10	1	45
A	5	1	50

5. Create the **OFFERS NOT DISPATCHED WMOT** as follows –

- a. Sort the list of *energy offer* blocks in **OFFERS NOT SCHEDULED FOR DISPATCH** from the cheapest at the bottom to the most expensive at the top based on the Price column.

Resource ID	MW	Block	Price
A	10	3	8
C	15	2	7
A	5	2	4

- b. Remove the price column in the *WMOT* that will be disseminated and published.

Resource ID	MW	Block
A	10	3
C	15	2
A	5	2

- c. Indicate the “Running Total” which is the incremental value based on the MW column and should start from the bottom of this list.

Resource ID	MW	Block	Running Total
A	10	3	30
C	15	2	20
A	5	2	5

6. Place the **OFFERS NOT SCHEDULED FOR DISPATCH** list on top of the **OFFERS SCHEDULED FOR DISPATCH** list.

Resource ID	MW	Block	Running Total
***** Offers Not Scheduled for Dispatch*****			
A	10	3	30
C	15	2	20
A	5	2	5
***** Offers Scheduled for Dispatch*****			
A	5	2	5
B	15	2	20
C	15	1	35
B	10	1	45
A	5	1	50

7. Place the *dispatch interval* date and hour at the top-most part of the file

10/4/2011 2:00:00 PM			
Resource ID	MW	Block	Running Total
***** Offers Not Scheduled for Dispatch*****			
A	10	3	30
C	15	2	20
A	5	2	5
***** Offers Scheduled for Dispatch*****			
A	5	2	5
B	15	2	20
C	15	1	35
B	10	1	45
A	5	1	50

Appendix C. Sample Contents of a Merit Order Table

	A	B	C	D	E
1	1/21/2012 2:00				
2	Resource ID	MW	Block	Running Total	
3	***** Offers Not Scheduled For Dispatch *****				
4	BAUANG_G01	180	1	1504.8	
5	BAUANG_G01	0	Pmin	1324.8	
6	SROQUE_G01	50	10	1324.8	
7	SROQUE_G01	50	9	1274.8	
8	SROQUE_G01	50	8	1224.8	
9	SROQUE_G01	40	7	1174.8	
10	SROQUE_G01	10	6	1134.8	
11	SROQUE_G01	20	5	1124.8	
12	SROQUE_G01	50	4	1104.8	
13	SROQUE_G01	35	3	1054.8	
14	S_ENRO_G01	110	1	1019.8	
15	S_ENRO_G01	0	Pmin	909.8	
16	T_ASIA_G01	5	2	909.8	
17	AMBUK_G01	104.6	1	904.8	
18	AMBUK_G01	0	Pmin	800.2	
19	ILIJAN_G01	10	10	800.2	
52	***** Offers Scheduled For Dispatch *****				
53	SUAL_G02	3.8	4	3.8	
54	SUAL_G02	21	3	24.8	
55	MSINLO_G01	15	8	39.8	
56	MSINLO_G01	20	7	59.8	
57	PAGBIL_G01	18	3	77.8	
58	SUAL_G02	9	2	86.8	
59	SUAL_G01	43.5	2	130.3	
60	PAGBIL_G01	44	2	174.3	
61	MSINLO_G01	30	6	204.3	
62	SUAL_G01	62.5	1	266.8	
63	MSINLO_G01	50	5	316.8	
64	PAGBIL_G01	200	1	516.8	

Appendix D. Content Structure of *Real-time dispatch* Results for the *System Operator*

The *Market Operator* shall submit the following information on the results of the *real-time dispatch* to the *System Operator*.

- a. MW schedules for each resource in the *real-time dispatch*
- b. Market Requirements [forecasted *load* (or *energy* requirement) and *reserve* requirements] per region
- c. Merit Order Table (as shown in Appendix C)

The following tables show the fields of each information to be transmitted to the *System Operator*.

a. <i>Real-time dispatch</i> schedules	
Column Name	Description
END_TIME	End/Target Time of the Dispatch interval
REFERENCE_NAME	Concatenates the Resource Name and the market product. The following lists the market products available. <ul style="list-style-type: none"> • “EN” for energy • “RU” for Regulation raise/upward • “RD” for Regulation lower/downward • “FR” for Fast Contingency Raise • “FL” for Fast Contingency Lower • “SR” for Slow Contingency Raise • “SL” for Slow Contingency Lower • “DR” for Delayed Contingency Raise • “DL” for Delayed Contingency Lower <p>Let us say that a generator’s resource name is 3GEN, hence, it will have a line item of 3GEN_EN to represent its Energy Schedule</p>
MW	MW schedule that is referenced to the End/Target Time

b. Market Requirements	
Column Name	Description
START_TIME	Start Time of the Dispatch interval
END_TIME	End/Target Time of the Dispatch interval
RUN_TYPE	Describes the type of market run, which is RTD
MKT_PRODUCT	Describes type of requirement <ul style="list-style-type: none"> • “EN” for energy • “RU” for Regulation raise/upward • “RD” for Regulation lower/downward • “FR” for Fast Contingency Raise • “FL” for Fast Contingency Lower

b. Market Requirements	
Column Name	Description
	<ul style="list-style-type: none"> • “SR” for Slow Contingency Raise • “SL” for Slow Contingency Lower • “DR” for Delayed Contingency Raise • “DL” for Delayed Contingency Lower
REGION_ID	Region name with the specific market requirement
REQ_MW	MW schedule that is referenced to the End/Target Time

c. Constraint Violations	
Column Name	Description
START_TIME	Start Time of the Projected Hour (for WAP and DAP) or Dispatch interval
END_TIME	End/Target Time of the Projected Hour (for WAP and DAP) or Dispatch interval
RUN_TYPE	Describes the type of market run, which is RTD
VIOLATION_TYPE	Describes the type of violation that occurred (i.e. Base Case Thermal, N-1 Contingency Thermal, under-generation, over-generation, etc.)
VIOLATED_NAME	Region, Equipment, or Load Name affected by Violation
VIOLATED_MW	MW Amount of Violation

Appendix E. Content Structure of SO Inputs to the *Market projections and Real-time dispatch*

The *System Operator* shall provide inputs to the *Market Management System* for the determination of the *market projections* and the *real-time dispatch*

a. Outage Schedules	
Column Name	Description
SCHEDULE_TYPE	Refers to the MMS' COP Schedule Type <ul style="list-style-type: none"> • "UnitOutagestatus" refers to the outage schedule for Generating units • "EquipmentOutagestatus" refers to the outage schedule for Equipment (lines, transformers, reactors, capacitors, switches)
VERSION	Version number of the Entry
OBJECT_ID	Complete MMS Map ID of the generating unit or equipment
START_TIME	Start Time
END_TIME	End Time
STATUS	Refers to the status of the unit/equipment, which should be "Out" in this schedule type

b. Security Limit	
Column Name	Description
SCHEDULE_TYPE1	Refers to the MMS' Schedule Type for the minimum operating limit, which should be "SecurityMinLimit" in this schedule type
SCHEDULE_TYPE2	Refers to the MMS' Schedule Type for the maximum operating limit, which should be "SecurityMaxLimit" in this schedule type
VERSION	Version number of the Entry
OBJECT_ID	Complete MMS Map ID of the generating unit
START_TIME	Start Time
END_TIME	End Time
VALUE1	Refers to the numerical value representing the minimum operating limit
VALUE2	Refers to the numerical value representing the maximum operating limit

c. HVDC Limit	
Column Name	Description
SCHEDULE_TYPE1	Refers to the MMS' Schedule Type for the Minimum HVDC Flow for the Forward Direction (Visayas-To-Luzon), which should be "HVDCForwardMin" in this schedule type

c. HVDC Limit	
Column Name	Description
SCHEDULE_TYPE2	Refers to the MMS' Schedule Type for the Maximum HVDC Flow for the Forward Direction (Visayas-To-Luzon), which should be "HVDCForwardMax" in this schedule type
SCHEDULE_TYPE3	Refers to the MMS' Schedule Type for the Minimum HVDC Flow for the Reverse Direction (Luzon-To-Visayas), which should be "HVDCReverseMin" in this schedule type
SCHEDULE_TYPE4	Refers to the MMS' Schedule Type for the Maximum HVDC Flow for the Reverse Direction (Luzon-To-Visayas), which should be "HVDCReverseMax" in this schedule type
VERSION	Version number of the Entry
OBJECT_ID	Complete MMS Map ID of the HVDC
START_TIME	Start Time
END_TIME	End Time
VALUE1	Refers to the numerical value representing the minimum HVDC flow for the Forward Direction (Visayas-To-Luzon)
VALUE2	Refers to the numerical value representing the maximum HVDC flow for the Forward Direction (Visayas-To-Luzon)
VALUE3	Refers to the numerical value representing the minimum HVDC flow for the Reverse Direction (Visayas-To-Luzon)
VALUE4	Refers to the numerical value representing the maximum HVDC flow for the Reverse Direction (Visayas-To-Luzon)

d. Transmission Limits	
Column Name	Description
SCHEDULE_TYPE1	Refers to the MMS' Schedule Type for the limit during normal conditions, which should be "TransmissionLimitNormal" in this schedule type
SCHEDULE_TYPE2	Refers to the MMS' Schedule Type for the limit during contingency (emergency) events, which should be "TransmissionLimitContingency" in this schedule type
VERSION	Version number of the Entry
OBJECT_ID	Complete MMS Map ID of the equipment (line or transformer)
START_TIME	Start Time
END_TIME	End Time
VALUE1	Refers to the numerical value representing the normal limit
VALUE2	Refers to the numerical value representing the contingency limit

e. Contingency List	
Column Name	Description
SCHEDULE_TYPE	Refers to the MMS' COP Schedule Type, which should be "ContingencyList" in this schedule type
VERSION	Version number of the Entry
OBJECT_ID	Complete MMS Map ID of the equipment
START_TIME	Start Time
END_TIME	End Time
STATUS	Refers to the status of the unit/equipment, which should be "Out" in this schedule type

f. Reserve Requirement	
Column Name	Description
SCHEDULE_TYPE	Refers to the MMS' COP Schedule Type for Reserve Requirement. The following are the available schedule types for reserves. <ul style="list-style-type: none"> • RegulationLowerReserve • RegulationRaiseReserve • FastContingencyLowerReserve • FastContingencyRaiseReserve • SlowContingencyLowerReserve • SlowContingencyRaiseReserve • DelayedContingencyLowerReserve • DelayedContingencyRaiseReserve
VERSION	Version number of the Entry
OBJECT_ID	Complete MMS Map ID of Reserve region
TARGET_TIME	Target Time
MW	MW value of the reserve region's requirement



Appendix F. Counting the Non-Compliance and Possible Breach

Part 1. APPLICATION OF THE DISPATCH CONFORMANCE STANDARDS

The examples under Appendix F present the parameters for counting of probable breach, summarized as follows:

ILLUSTRATION REFERENCE	PARAMETERS
Example 1: No Probable Breach - Compliance within Reaction Period	1. The non-compliance count (NC) starts when the actual dispatch is beyond any of the dispatch threshold levels, and continues or increments as the non-compliance continues. If the unit becomes compliant during the reaction period, the NC count stops and is reset to zero (0) at the dispatch interval that the unit becomes compliant. As the unit is already compliant during the reaction period, both the probationary period count (PR) the probable breach count (PB) do not start. The unit is not in breach of the dispatch conformance standard in this situation.
Example 2: No Probable Breach – Compliance after Reaction Period	2. If the unit was non-compliant for the entire reaction period but becomes compliant immediately at the dispatch interval after the reaction period (i.e., starting on 5 th interval), the NC count resets to zero. As the unit became compliant immediately after the reaction period, the probationary period count (PR) does not start. The unit is not in breach of the dispatch conformance standard in this situation.
Example 3 – With Probable Breach: Non-Compliance beyond Reaction Period.	3. If the unit was non-compliant for the entire reaction period and continues to be non-compliant after the reaction period, the NC count continues to increment and the PB count then starts on the dispatch interval after the reaction period (i.e., fifth interval). In this situation, the unit is already in probable breach of the dispatch conformance standard.
	4. If the unit that is already in breach becomes compliant (i.e., after the fifth interval), the NC count is tolled or is not incremented but does not reset to zero (0), while the PB count stops and the PR count starts.
Example 4: With Probable Breach – Compliance not Sustained <u>WITHIN</u> the Probationary Period.	a. If the compliance is not sustained for three successive intervals (i.e., the unit becomes again becomes non-compliant before the probationary period ends), the PR count stops, the NC count again increments, and the PB count continues.
Example 5: Compliance Sustained within and after Probationary Period.	b. If the compliance is sustained for three successive intervals (i.e., probationary period) and continues thereafter, the NC count then resets to zero at the third dispatch interval (i.e., dispatch interval when the probationary period is considered passed). As the unit is already compliant, the PB count stops.



Dispatch Protocol

WESM-DP-013.2

Effective Date:

**Example 6: Compliance not Sustained
AFTER Probationary Period.**

- c. If the compliance is sustained during the probationary period but the unit becomes non-compliant immediately after the probationary period (i.e., on the fourth interval), the NC count will start anew (i.e., start at count one).

Examples 1 to 6:

- Dispatch threshold is computed at: (a) 1.5%MW of the RTD Schedule; or (b) -3% of the RTD Schedule, or (c) +/-1MW, whichever is higher/applicable. Reaction period is four (4) dispatch intervals, and probationary period is three (3) dispatch intervals.
- Reference Period: September 2016 billing month.



Dispatch Protocol

WESM-DP-013.2
Effective Date:

- **Example 1: No Probable Breach – Compliance Within Reaction Period**

Illustration:

Legend: Non-Compliance Compliance – Probation
 Possible Breach Compliance – Probation Passed

Trading Day	Hour	Minute	RTD Schedule	Actual Dispatch	Deviation, MW	Deviation, %	Non-Compliance Counter (NC)	Probation Counter (PR)	Probable Breach Counter (PB)
26-Aug-16	9	55	210	212.08	2.08	0.99%	0		
26-Aug-16	9	60	210	212.08	2.08	0.99%	0		
26-Aug-16	10	5	210	212.08	2.08	0.99%	0		
26-Aug-16	10	10	210	212.08	2.08	0.99%	0		
26-Aug-16	10	15	210	212.08	2.08	0.99%	0		
26-Aug-16	10	20	210	217.48	7.48	3.56%	1		
26-Aug-16	10	25	210	214.67	4.67	2.22%	2		
26-Aug-16	10	30	210	217.79	7.79	3.71%	3		
26-Aug-16	10	35	210	210.36	0.36	0.17%	0		
26-Aug-16	10	40	210	209.97	-0.03	-0.01%	0		
26-Aug-16	10	45	210	209.97	-0.03	-0.01%	0		
26-Aug-16	10	50	210	209.97	-0.03	-0.01%	0		
26-Aug-16	10	55	210	209.97	-0.03	-0.01%	0		
26-Aug-16	10	60	210	209.97	-0.03	-0.01%	0		



Dispatch Protocol

WESM-DP-013.2
Effective Date:

- **Example 2: No Probable Breach – Compliance After Reaction Period**

Illustration:

Legend:

 Non-Compliance	 Compliance – Probation
 Possible Breach	 Compliance – Probation Passed

Trading Day	Hour	Minute	RTD Schedule	Actual Dispatch	Deviation, MW	Deviation, %	Non-Compliance Counter (NC)	Probation Counter (PR)	Probable Breach Counter (PB)
26-Aug-16	9	55	210	215.00	5.00	2.38%	1		
26-Aug-16	9	60	210	216.70	6.70	3.19%	2		
26-Aug-16	10	5	210	216.56	6.56	3.12%	3		
26-Aug-16	10	10	210	218.27	8.27	3.94%	4		
26-Aug-16	10	15	210	212.08	2.08	0.99%	0		
26-Aug-16	10	20	210	212.08	2.08	0.99%	0		
26-Aug-16	10	25	210	212.08	2.08	0.99%	0		
26-Aug-16	10	30	210	212.08	2.08	0.99%	0		
26-Aug-16	10	35	210	212.08	2.08	0.99%	0		
26-Aug-16	10	40	210	212.08	2.08	0.99%	0		
26-Aug-16	10	45	210	212.08	2.08	0.99%	0		
26-Aug-16	10	50	210	212.08	2.08	0.99%	0		
26-Aug-16	10	55	210	212.08	2.08	0.99%	0		
26-Aug-16	10	60	210	212.08	2.08	0.99%	0		



Dispatch Protocol

WESM-DP-013.2
Effective Date:

• **Example 3: With Probable Breach – Non Compliance Beyond the Reaction Period**

Illustration:

Legend:

- Non-Compliance
- Compliance – Probation
- Possible Breach
- Compliance – Probation Passed

Trading Day	Hour	Minute	RTD Schedule	Actual Dispatch	Deviation, MW	Deviation, %	Non-Compliance Counter (NC)	Probation Counter (PR)	Probable Breach Counter (PB)
26-Aug-16	1	5	210	209.27	-0.73	-0.35%	0		
26-Aug-16	1	10	210	206.89	-3.11	-1.48%	0		
26-Aug-16	1	15	210	215.89	5.89	2.80%	1		
26-Aug-16	1	20	210	216.79	6.79	3.23%	2		
26-Aug-16	1	25	210	214.10	4.10	1.95%	3		
26-Aug-16	1	30	210	213.66	3.66	1.74%	4		
26-Aug-16	1	35	210	215.67	5.67	2.70%	5		1
26-Aug-16	1	40	210	214.90	4.90	2.33%	6		1
26-Aug-16	1	45	210	216.10	6.10	2.90%	7		1
26-Aug-16	1	50	210	213.66	3.66	1.74%	8		1
26-Aug-16	1	55	210	215.89	5.89	2.80%	9		1
26-Aug-16	1	60	210	216.79	6.79	3.23%	10		1
26-Aug-16	2	5	210	214.10	4.10	1.95%	11		1
26-Aug-16	2	10	210	211.68	1.68	0.80%		1	



Dispatch Protocol

WESM-DP-013.2
Effective Date:

- **Example 4:** With Probable Breach – Compliance Not Sustained WITHIN the Probationary Period

Illustration:

Legend: Non-Compliance Compliance – Probation
 Possible Breach Compliance – Probation Passed

Trading Day	Hour	Minute	RTD Schedule	Actual Dispatch	Deviation, MW	Deviation, %	Non-Compliance Counter (NC)	Probation Counter (PR)	Probable Breach Counter (PB)
26-Aug-16	2	35	210	213.27	3.27	1.56%	1		
26-Aug-16	2	40	210	214.50	4.50	2.14%	2		
26-Aug-16	2	45	210	213.97	3.97	1.89%	3		
26-Aug-16	2	50	210	213.27	3.27	1.56%	4		
26-Aug-16	2	55	210	214.50	4.50	2.14%	5		1
26-Aug-16	2	60	210	213.97	3.97	1.89%	6		1
26-Aug-16	3	5	210	213.27	3.27	1.56%	7		1
26-Aug-16	3	10	210	214.50	4.50	2.14%	8		1
26-Aug-16	3	15	210	213.48	3.48	1.66%	9		1
26-Aug-16	3	20	210	213.97	3.97	1.89%	10		1
26-Aug-16	3	25	210	213.27	3.27	1.56%	11		1
26-Aug-16	3	30	210	212.78	2.78	1.32%	11	1	
26-Aug-16	3	35	210	213.27	3.27	1.56%	12		1
26-Aug-16	3	40	210	214.50	4.50	2.14%	13		1
26-Aug-16	3	45	210	206.28	-3.72	-1.77%	13	1	



Dispatch Protocol

WESM-DP-013.2
Effective Date:

• **Example 5: Compliance Within and After Probationary Period**

Illustration:

Legend:

- Non-Compliance
- Compliance – Probation
- Possible Breach
- Compliance – Probation Passed

Trading Day	Hour	Minute	RTD Schedule	Actual Dispatch	Deviation, MW	Deviation, %	Non-Compliance Counter (NC)	Probation Counter (PR)	Probable Breach Counter (PB)
26-Aug-16	1	5	210	209.27	-0.73	-0.35%	0		
26-Aug-16	1	10	210	206.89	-3.11	-1.48%	0		
26-Aug-16	1	15	210	215.89	5.89	2.80%	1		
26-Aug-16	1	20	210	216.79	6.79	3.23%	2		
26-Aug-16	1	25	210	214.10	4.10	1.95%	3		
26-Aug-16	1	30	210	213.66	3.66	1.74%	4		
26-Aug-16	1	35	210	215.67	5.67	2.70%	5		1
26-Aug-16	1	40	210	214.90	4.90	2.33%	6		1
26-Aug-16	1	45	210	216.10	6.10	2.90%	7		1
26-Aug-16	1	50	210	213.66	3.66	1.74%	8		1
26-Aug-16	1	55	210	215.89	5.89	2.80%	9		1
26-Aug-16	1	60	210	216.79	6.79	3.23%	10		1
26-Aug-16	2	5	210	214.10	4.10	1.95%	11		1
26-Aug-16	2	10	210	211.68	1.68	0.80%	11	1	
26-Aug-16	2	15	210	206.89	-3.11	-1.48%	11	2	
26-Aug-16	2	20	210	205.79	-4.21	-2.00%	0	3	
26-Aug-16	2	25	210	206.81	-3.19	-1.52%	0	0	
26-Aug-16	2	30	210	206.59	-3.41	-1.62%	0	0	



Dispatch Protocol

WESM-DP-013.2
Effective Date:

- **Example 6: With Probable Breach – Compliance Not Sustained AFTER the Probationary Period**

Illustration:

Legend:

 Non-Compliance	 Compliance – Probation
 Possible Breach	 Compliance – Probation Passed

Trading Day	Hour	Minute	RTD Schedule	Actual Dispatch	Deviation, MW	Deviation, %	Non-Compliance Counter (NC)	Probation Counter (PR)	Probable Breach Counter (PB)
26-Aug-16	15	10	210	213.97	3.97	1.89%	1		
26-Aug-16	15	15	210	214.10	4.10	1.95%	2		
26-Aug-16	15	20	210	215.60	5.60	2.67%	3		
26-Aug-16	15	25	210	217.90	7.90	3.76%	4		
26-Aug-16	15	30	210	216.00	6.00	2.86%	5		1
26-Aug-16	15	35	210	215.80	5.80	2.76%	6		1
26-Aug-16	15	40	210	218.00	8.00	3.81%	7		1
26-Aug-16	15	45	210	222.89	12.89	6.14%	8		1
26-Aug-16	15	50	210	209.18	-0.82	-0.39%	8	1	
26-Aug-16	15	55	210	211.20	1.20	0.57%	8	2	
26-Aug-16	15	60	210	203.80	-6.20	-2.95%	0	3	
26-Aug-16	16	5	210	188.70	-21.30	-10.14%	1		
26-Aug-16	16	10	210	203.47	-6.53	-3.11%	2		
26-Aug-16	16	15	200	203.47	-6.53	-3.11%	3		



Dispatch Protocol

WESM-DP-013.2
Effective Date:

Part 2. NON-COMPLIANCE DURING TRADING INTERVALS WITH IMPENDING EXCESS GENERATION

References	WESM Rules Clause 3.9.8.3 and WESM Dispatch Protocol (Issue 13) Section 12.5.2 (g), and Section 18.3
Parameters	Dispatch threshold is computed at: (a) 1.5%MW of the RTD Schedule ; or (b) -3% of the RTD Schedule , or (c) +/-1MW , whichever is higher/applicable. Non-compliance count progresses as non-compliance continues. Counting of breach starts upon first instance of non-compliance and will continue as long as excess generation condition continues. No reaction time is allowed as the Trading Participant is expected to immediately comply with its dispatch schedule.
Example	Impending Excess Generation at Hour 0500H. No impending Excess Generation at Hour 0600H.

Hour	Minute	RTD Schedule	Actual Dispatch	Deviation, MW	Deviation, %	DISPATCH CONFORMANCE STANDARDS MONITORING			IMPENDING EXCESS GENERATION MONITORING		APPLICABLE RULE
						Non-Compliance Count (NC)	Probation Count (PR)	Probable Breach Count (PB)	DAP Run Results	Probable Breach Counter (PB)	
5	5	210	213.66	3.66	1.74%	1			Excess Generation	1	Compliance During Impending Excess Generation (WESM Rules Clause 3.9.8.3, and WESM Dispatch Protocol, Section 12.5.2 (g), and Section 18.3. <i>There will be no double counting. If PB counts overlap, the "excess generation" rule prevails.</i>
5	10	210	214.19	4.19	2.00%	2			Excess Generation	1	
5	15	210	215.00	5.00	2.38%	3			Excess Generation	1	
5	20	210	214.00	4.00	1.90%	4			Excess Generation	1	
5	25	210	214.80	4.80	2.29%	5		1	Excess Generation	1	
5	30	210	215.00	5.00	2.38%	6		1	Excess Generation	1	
5	35	210	214.80	4.80	2.29%	7		1	Excess Generation	1	
5	40	210	214.19	4.19	2.00%	8		1	Excess Generation	1	
5	45	210	216.00	6.00	2.86%	9		1	Excess Generation	1	
5	50	210	216.10	6.10	2.90%	10		1	Excess Generation	1	
5	55	210	214.00	4.00	1.90%	11		1	Excess Generation	1	
5	00	210	213.66	3.66	1.74%	12		1	Excess Generation	1	
6	5	210	214.19	4.19	2.00%	13		1	-	1	Dispatch Conformance Standards (WESM Rules clause 3.8.4.1, and WESM
6	10	210	215.00	5.00	2.38%	14		1	-	1	
6	15	210	214.00	4.00	1.90%	15		1	-	1	
6	20	210	214.80	4.80	2.29%	16		1	-	1	



Dispatch Protocol

WESM-DP-013.2
Effective Date:

Hour	Minute	RTD Schedule	Actual Dispatch	Deviation, MW	Deviation, %	DISPATCH CONFORMANCE STANDARDS MONITORING			IMPENDING EXCESS GENERATION MONITORING		APPLICABLE RULE
						Non-Compliance Count (NC)	Probation Count (PR)	Probable Breach Count (PB)	DAP Run Results	Probable Breach Counter (PB)	
6	25	210	215.00	5.00	2.38%	17		1	-	1	Dispatch Protocol, Chapter 12)
6	30	210	214.80	4.80	2.29%	18		1	-	1	
6	35	210	214.19	4.19	2.00%	19		1	-	1	
6	40	210	216.00	6.00	2.86%	20		1	-	1	
6	45	210	216.10	6.10	2.90%	21		1	-	1	
6	50	210	214.00	4.00	1.90%	22		1	-	1	
6	55	210	214.00	4.00	1.90%	22		1	-	1	
6	00	210	214.00	4.00	1.90%	22		1	-	1	